

2024 EDITION

*We build the pool...  
You create the lifestyle.™*



**COMPOSITE  
POOLS USA**

*One-piece Fiberglass Pool Manufacturer*



**MADE IN USA**



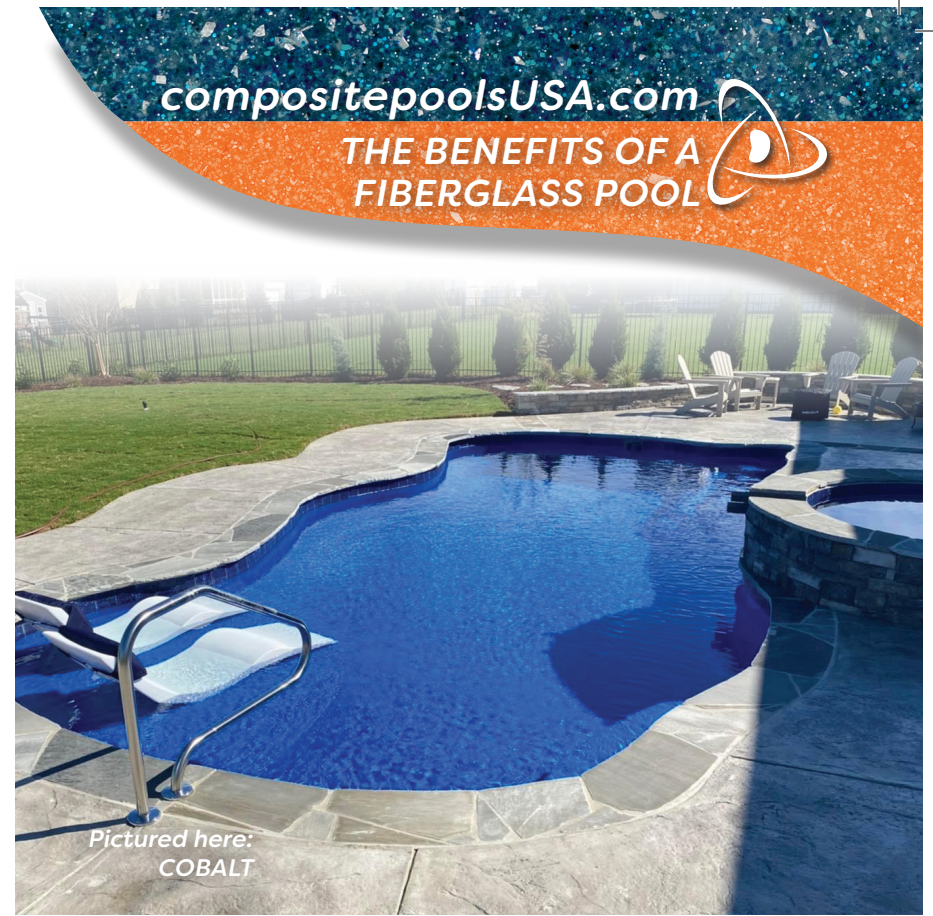

compositepoolsUSA.com  
 THE BENEFITS OF A  
 FIBERGLASS POOL

Pictured here:  
 COBALT

## Create your own Backyard Oasis

### ENERGY EFFICIENT AND LOW MAINTENANCE

The fiberglass used to manufacture our pools inherently acts as a natural insulator. With less fluctuation in temperature, your filter and heater work less than they would with other types of pools.

The smooth surface of our pools naturally resists the attaching of algae which reduces the amount of chemical treatment needed for healthy water conditions.

Fiberglass pools require no re-plastering, changing vinyl liners or acid washing. Maintenance is minimal.

### MODULAR OPTIONS = FLEXIBILITY

Choose from over 50 designs and shapes  
 OR combine more than one to customize  
 your own backyard oasis.

### MAKE IT A COMBO!

Ask us how to make any compatible model  
 into a pool spa combo.



Pictured here:  
 COBALT



Pictured here:  
 OXFORD BLUE



Pictured here:  
 OXFORD BLUE  
 1-855-464-3101 • info@compositepoolsusa.com



Pictured here:  
 COBALT





compositepoolsUSA.com

# INTRODUCING NEW MODELS & SIZES

Please call for availability and lead time

**WISCONSIN**  
12' wide x 30' long  
3'6" to 6' deep

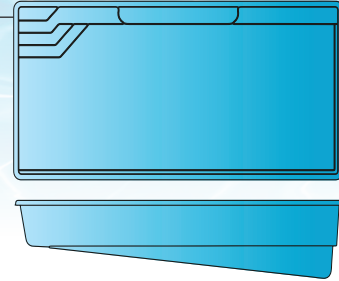

features:

- Medium, rectangular pool
- Auto cover ready
- Gradual slope
- Unobstructed swim lane
- Full length seating bench

**ALASKA**  
10' wide x 15' long  
4' deep

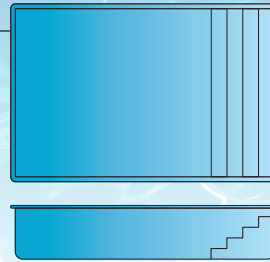
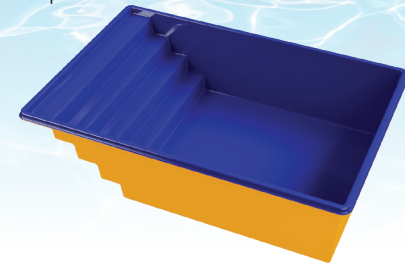

features:

- Small, rectangular pool
- Auto cover ready
- Constant depth/Flat bottom
- Full width stair entry

**UTAH** 10' wide x 20' long  
4' deep

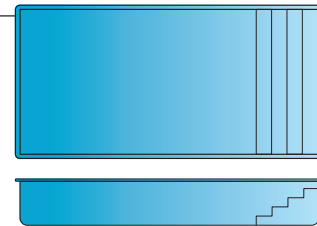
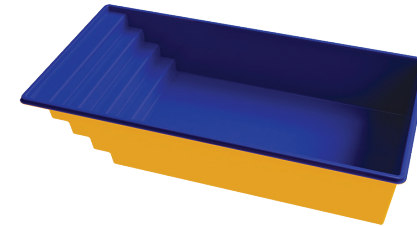

features:

- Small, rectangular pool
- Auto cover ready
- Constant depth/Flat bottom
- Full width stair entry

**NEVADA**  
12' wide x 25' long  
4'6" deep

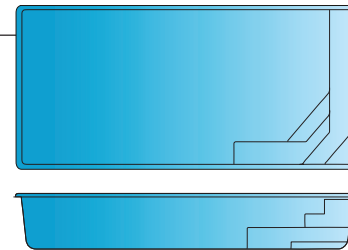
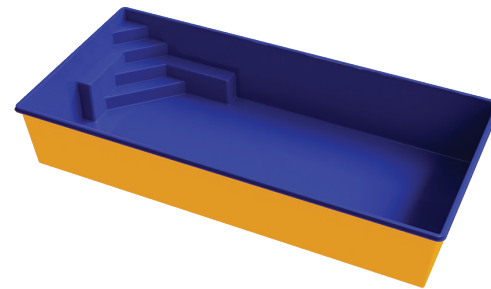

features:

- Small, rectangular pool
- Auto cover ready
- Constant depth/Flat bottom
- Corner stair entry
- Built in seating benches

**ALABAMA**  
14' wide x 32' long  
3'6" to 5'10" deep

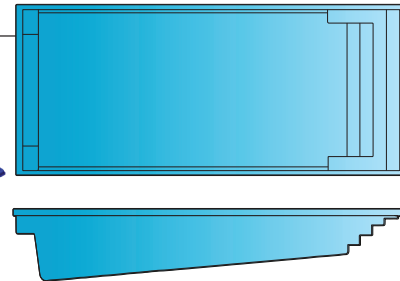
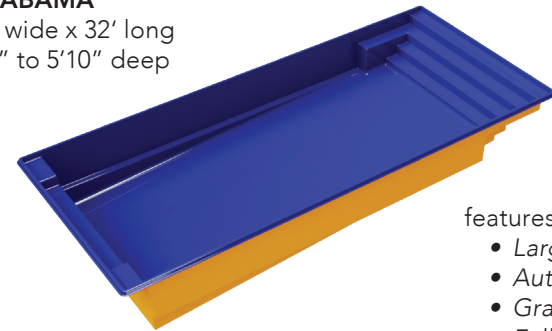

features:

- Large, rectangular pool
- Auto cover ready
- Gradual slope
- Full width stair entry
- Full width deep end seating bench
- Perimeter convenience ledge

**LOUISIANA**  
7' wide x 14' long  
1'9" to 3'6" deep

**NEW  
FREEFORM  
SHAPE!**

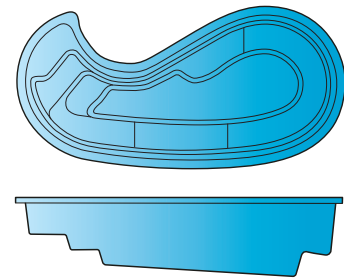

features:

- Seating at various heights
- Splash pool by day, spa by night
- Standalone or combine next to any pool



Pictured here:  
**OHIO**  
IN PEARL GREY



Pictured here:  
**FREEDOM 34**  
IN AIRFORCE BLUE



Pictured here:  
**GEORGIA**  
IN AIRFORCE BLUE



Pictured here:  
**NEW HAMPSHIRE**  
IN MARBLE BEIGE



Pictured here:  
**CONNECTICUT**  
IN COBALT



Pictured here:  
**OREGON**  
IN COBALT

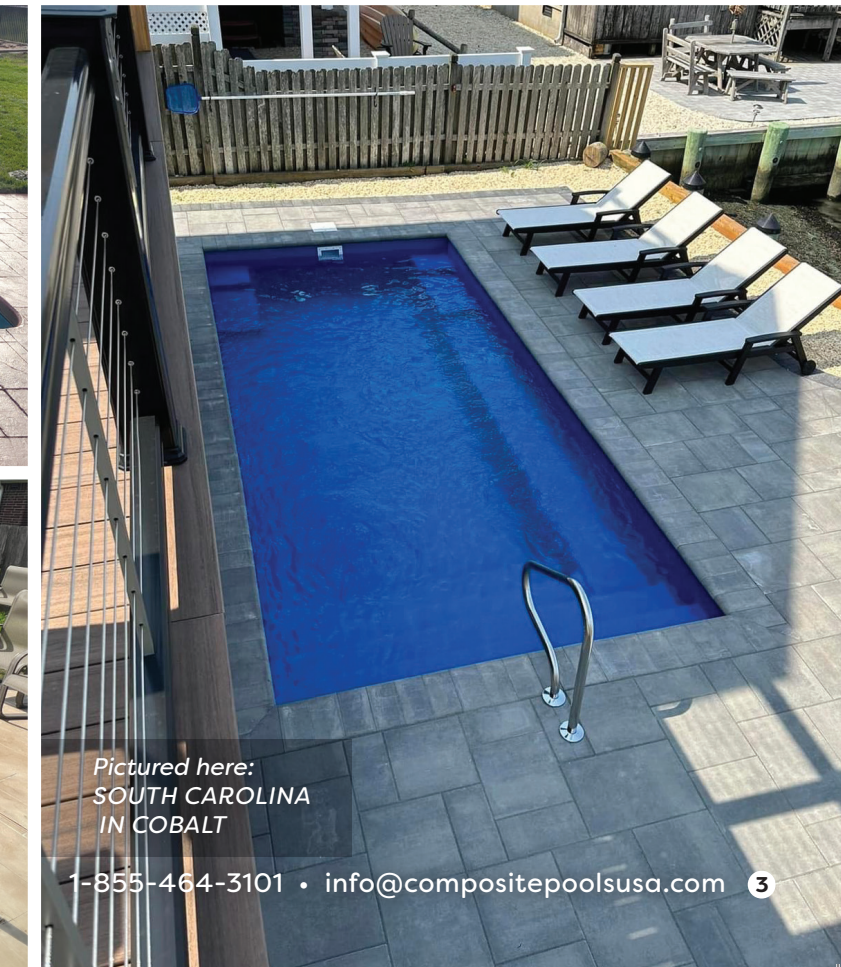

Pictured here:  
**SOUTH CAROLINA**  
IN COBALT



**SEE PAGE 15 FOR MORE NEW DESIGNS!  
NEW MEXICO POOL NOW AVAILABLE  
IN LARGER WIDTHS**



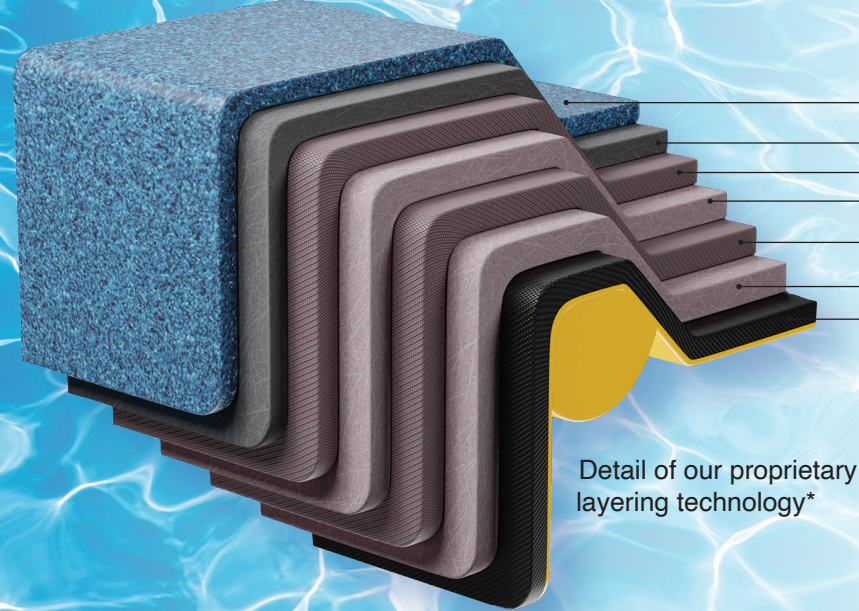

Detail of our proprietary layering technology\*

*A new standard in composite pool manufacturing*

- 1) Hydra Stone® is not your typical gel coat. Our solid surface gives you the best finish in the industry for a fiberglass pool. Two applications of 18 mils of coating (total of 36 mils) to ensure maintenance-free and lasting beauty.
- 2) 100 % Vinyl Ester Resin combined with gun woving creating the best barrier coat in the industry. This layer helps protect your pool from blistering and corrosion.
- 3) 4108/41 ounces of material - Our pools are made out of technologically advanced intricately woven glass fabric, some of the best materials used in the industry. It performs multiple tasks such as providing a good surface finish, impact and abrasion resistance, and structural integrity.
- 4) Chopped Strand Matt (CSM) - Consists of glass fibers laid randomly across each other and held together by polyester resin. This brings strength and thickness to our unique fiberglass pools.
- 5) 4108/41 ounces of material - An extra layer for maximum corrosion resistance; also heat resistant and blended for toughness.
- 6) Chop Strand Glass - We have another layer of Strand glass. Our pools are made with more reinforcement than those made by any other company.
- 7) Kevlar - Added to enhance the structural strength of the fiberglass shell. Kevlar is a strong heat resistant synthetic fiber and is five times stronger than steel.

\* Illustration represents our typical pool manufacturing process. Fiberglass layering, materials and structural features are designed specifically to each particular pool model, its shape, size, and areas requiring greater or less reinforced structural integrity. For more information on our process, please contact the factory.

<b>CONTENTS - 2024 EDITION</b> .....	PAGE
BENEFITS OF A FIBERGLASS POOL .....	1
NEW MODELS .....	2
FEATURED MODELS .....	3
STRUCTURAL TECHNOLOGY .....	4-5
TOTALLY CUSTOMIZABLE PACKAGES .....	6-7
FREEFORM POOLS .....	9-12
RECTANGULAR POOLS .....	13-16
SPAS AND TANNING LEDGES .....	17-19
INSTALLATION INFORMATION/SAFETY .....	20
CUSTOMIZATION OPTIONS .....	21-29



*Unique unibody design provides superior durability*



- 1) Lifting and tie down placements installed.
- 2) Enclosed or reinforced coping gives it a unique unibody design.
- 3) Additional layers are added strategically on steps, walls and radius parts of the pool.
- 4) Honeycombed material for superior support and strengthening on walls, steps and coping.
- 5) Exterior proprietary sealer utilized to seal every pool from exterior moisture and ground water.



All CompositepoolsUSA fiberglass pools are manufactured in a controlled factory environment using only the finest available materials. Every pool must pass a stringent quality control inspection prior to being shipped.

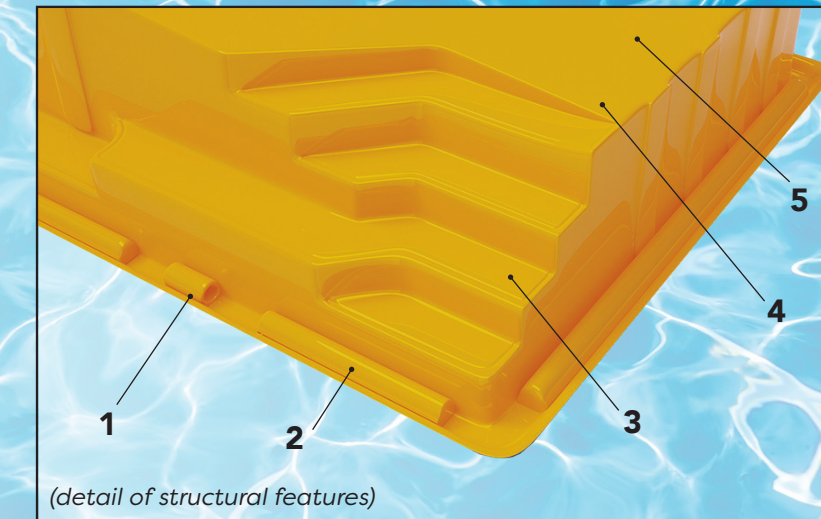

(detail of structural features)





Our goal is to make a pool that suits your family's budget & lifestyle  
**Totally Customizable Packages**

**DIY - AS EASY AS 1-2-3** Buy directly from the factory and save thousands!



**The DIY Package**

**WE DELIVER THE POOL - YOU DO THE REST\***

**INCLUDES:**

- Pool Shell
- Pump
- Filter
- Frog mineral system
- Lights

*All Pools include 1 skimmer. Return fittings and main drains are optional unless specified.*

*Custom and brand equipment packages available*

**\* ASSISTANCE IS REQUIRED FOR FIRST TIME INSTALLERS:** FOR YOUR WARRANTY TO BE VALID, AN EXPERIENCED PROFESSIONAL POOL INSTALLER IS REQUIRED TO HELP GUIDE YOU THROUGH INSTALLATION PROCESS.

**NOTE:** For warranty to be valid, all non-professional installers are required to have assistance of a professional installer on-site. All DIY purchases require one-day onsite assistant for fee defined in your contract. Our professional pool installation technician will supervise setting of the pool shell into your prepared hole, and the cutting of necessary fittings.

**REQUIREMENTS FOR WARRANTY:**

Bond beam to lock the pool in within 10 days of installation is required. *DIY and Non-Dealer installations require photos of the entire installation process. For warranty to be valid you must provide photos of the following:* 1.) Excavation; 2.) Shell drop; 3.) Hole base; 4.) Backfill; 5.) Plumbing; 6.) Prior to decking with rebar and wire if used bonded; 7.) Bond beam and/or decking installed



We are the only East Coast manufacturer that sells factory-direct through our independent dealer network and distribution yards. Contact us direct or visit your local dealer.



**Dig-Drop-Set Package**

**WE INSTALL YOUR POOL  
 YOU DO THE ELECTRICAL & FINISHING**

**INCLUDES:**

- Pool Shell
- Pump
- Filter
- Frog mineral system
- Lights
- Installation

*All Pools include 1 skimmer. Return fittings and main drains are optional unless specified.*

- Electric done by others
- Concrete done by others

**REQUIREMENTS FOR WARRANTY:**

Bond beam to lock the pool in within 10 days of installation is required. *DIY and Non-Dealer installations require photos of bond beam installed or concrete decking.*

**Turnkey Package**

**WE INSTALL YOUR POOL,  
 ELECTRICAL AND CONCRETE**

**INCLUDES:**

- Pool Shell
- Pump Filter
- Frog Mineral system
- Lights
- Installation
- Electric up to 50'
- 3' wide cantilever
- concrete

*All Pools include 1 skimmer. Return fittings and main drains are optional unless specified.*

*Custom back yard packages available upon request*

*Additional Electric requirements that exceed 50 feet will be at additional cost based on footage.*

*Additional Concrete exceeding 3 foot wide cantilever will be at additional cost based on square footage.*

*Stamped, colored or exposed aggregate concrete or pavers available at additional cost.*

*Pump and filter upgrades priced per your selection.*

*Salt chlorinator option priced per your selection.*





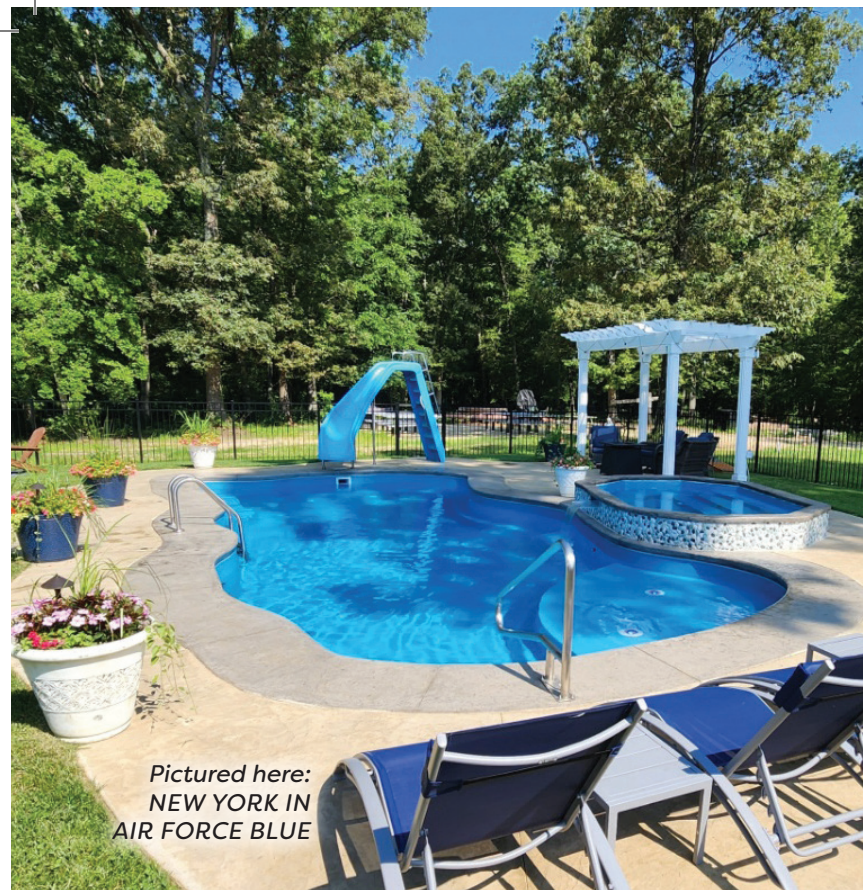

Pictured here:  
**NEW YORK IN  
 AIR FORCE BLUE**



Pictured here:  
**COBALT**

**WYOMING**  
 18' wide x 44' long  
 3'8" to 8'1" deep

**OUR LARGEST  
 FREEFORM POOL**

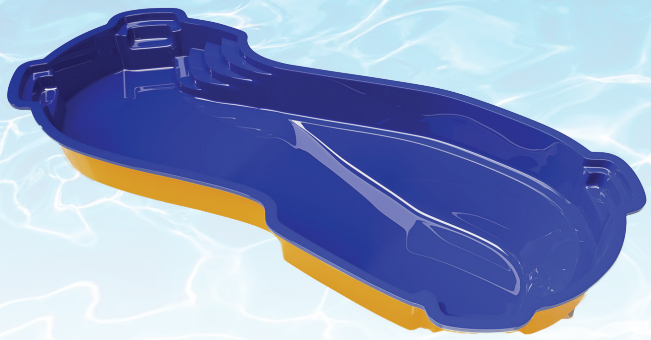
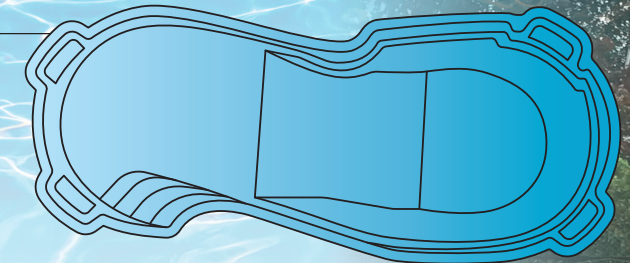

features:

- Unobstructed swim lane
- 4 convenient swim outs
- Flat shallow, gentle slope, deep end hopper
- Perimeter convenience ledge

**TEXAS**  
 18' wide x 42' long  
 3'6" to 7' deep

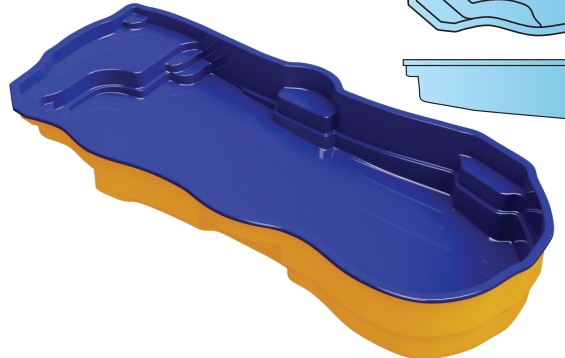
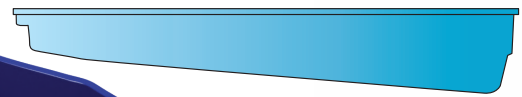
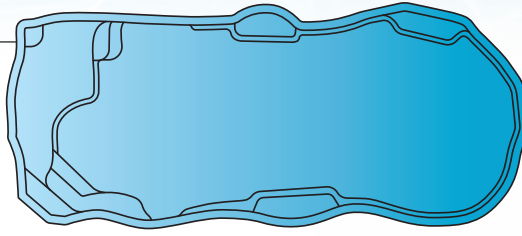

features:

- Large pool
- Unique, freeform design
- Built-in tanning ledge 12" deep
- Multiple entry/exit points
- Perimeter convenience ledge

**FREEDOM 34**  
 15' wide x 34' long  
 3'6" to 7' deep

**NEW!**

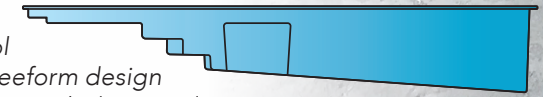
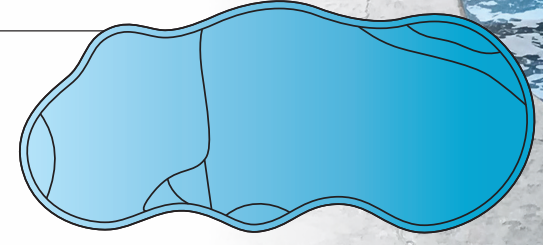

features:

- Large pool
- Unique, freeform design
- Built-in tanning ledge 12" deep
- Multiple entry/exit points

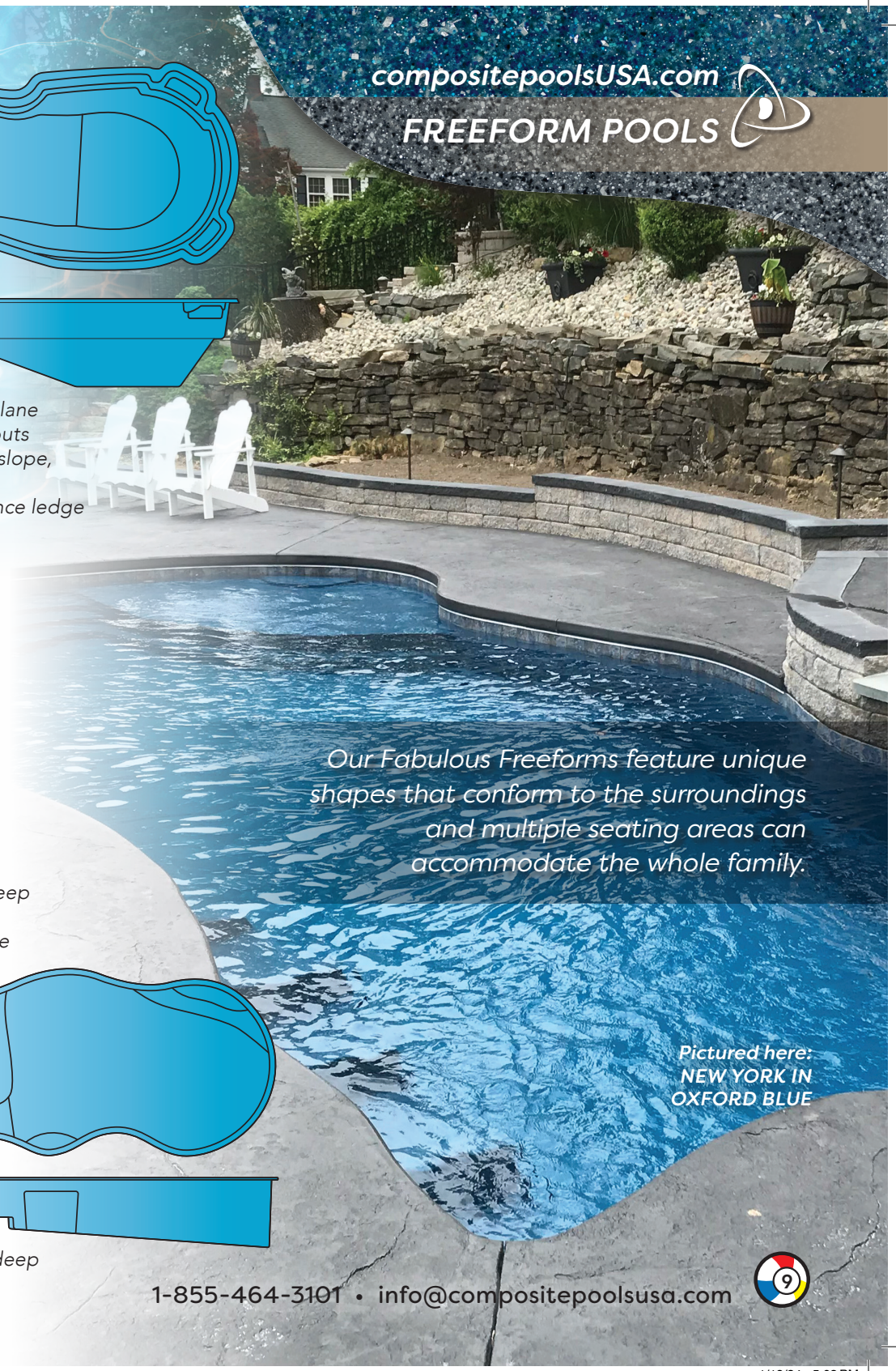

*Our Fabulous Freeforms feature unique shapes that conform to the surroundings and multiple seating areas can accommodate the whole family.*

Pictured here:  
**NEW YORK IN  
 OXFORD BLUE**



Pictured here:  
**COBALT**



Pictured here:  
**CONNECTICUT  
 IN OCEAN BREEZE**



1-855-464-3101 • info@compositepoolsusa.com



1-855-464-3101 • info@compositepoolsusa.com





**NEBRASKA**  
16' wide x 40' long  
3'5" to 8' deep

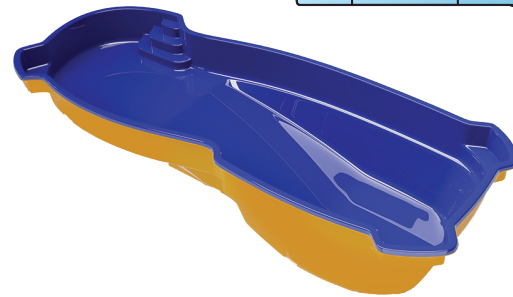
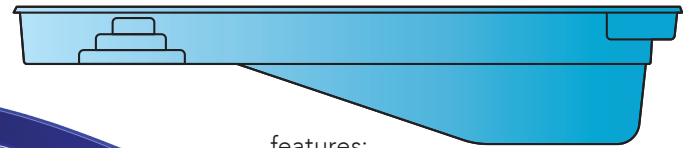
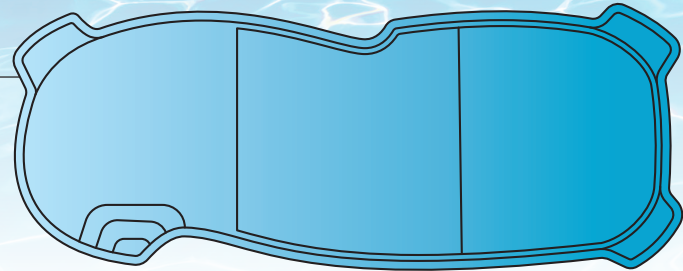

features:

- Large, freeform pool
- 3 convenient swim outs
- Unobstructed swim lane
- Full 8' deep end
- Flat shallow, gentle slope, deep end hopper
- Perimeter convenience ledge

**IOWA**  
15'6" wide x 35' long  
3'7" to 5'9" deep

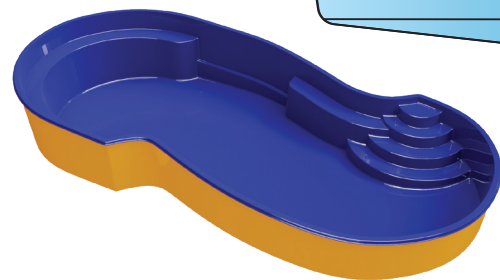
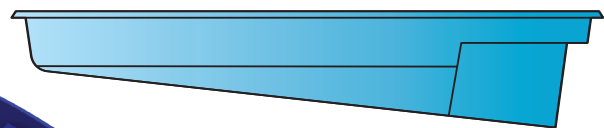
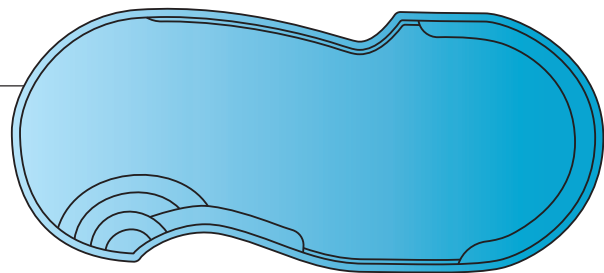

features:

- Large freeform pool
- Modest depth
- Gentle slope from shallow to deep
- Wrap around deep end bench
- Unobstructed swim lane
- Perimeter convenience ledge

**NEW YORK**  
16' wide x 35' long  
3'4" to 6'5" deep

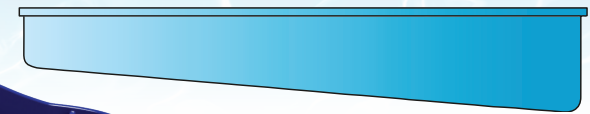
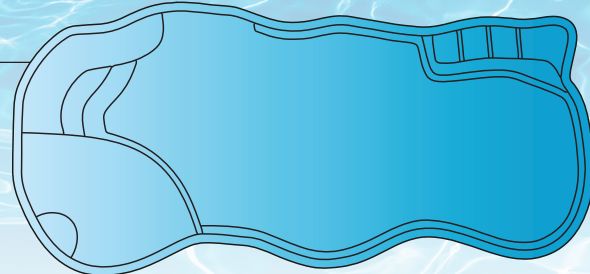

features:

- Large pool
- Unique, freeform design
- Gentle slope from shallow to deep
- Perimeter convenience ledge
- Built-in Tanning Ledge 12" deep
- Multiple entry/exit points
- Built in benches
- Comfortable seating for 3



**MARYLAND**  
14" wide x 30' long  
3'7" to 5'11" deep

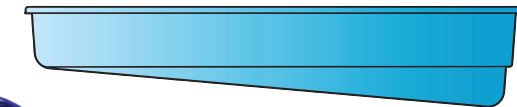
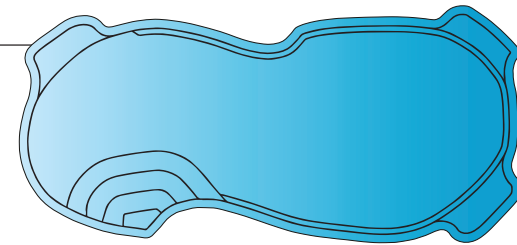

features:

- Medium, free form design
- 3 convenient swim outs
- Unobstructed swim lane
- Perimeter convenience ledge
- Wedding cake style stairs

**OREGON**  
13' wide x 29' long  
3'9" to 5'5" deep

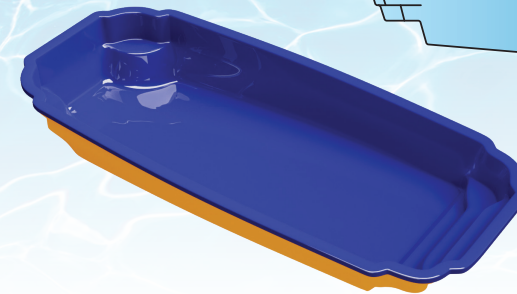
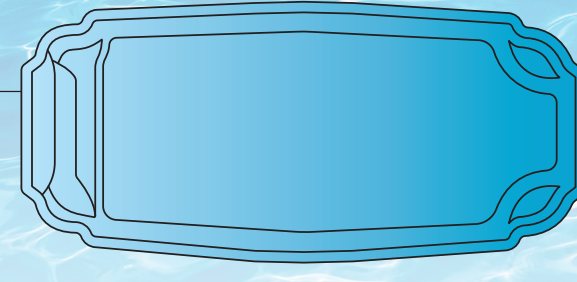

features:

- Medium, unique design
- Shallow & deep end entry/exit points
- Unobstructed swim lane
- Gradual slope

**CONNECTICUT**  
13' wide x 26' long  
3'6" to 5'6" deep

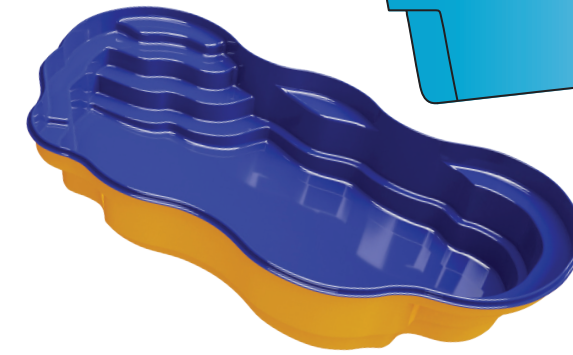
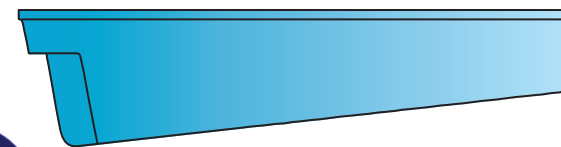
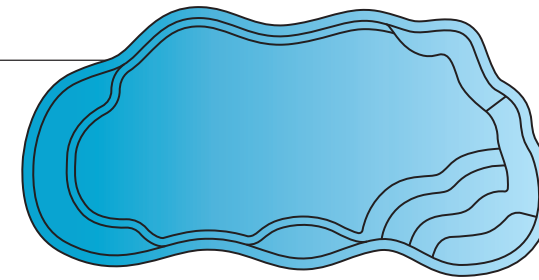

features:

- Medium, freeform design
- Gradual slope
- Deep end seating bench
- Multiple seating benches
- Perimeter convenience ledge
- Social pool

**VIRGINIA**  
13' wide x 26' long  
3'6" to 5'6" deep

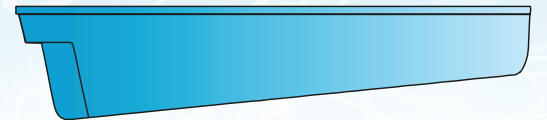
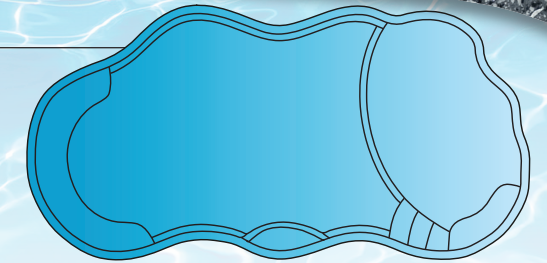

features:

- Built-in Tanning Ledge 12" deep
- Medium, freeform design
- Gradual slope
- Deep end seating bench
- Multiple seating benches
- Perimeter convenience ledge
- Social pool

**NORTH CAROLINA**  
12' wide x 25' long  
3'7" to 5'5" deep

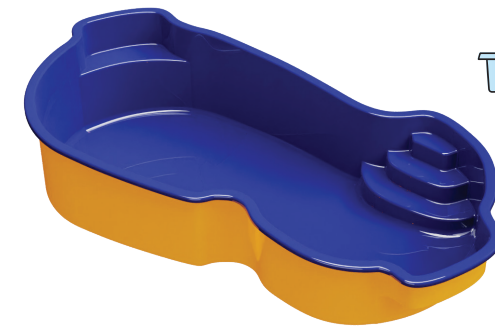
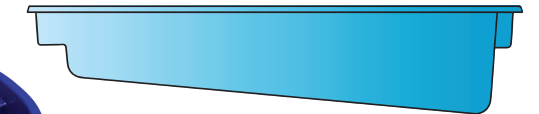
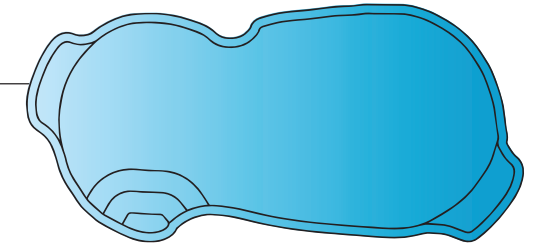

features:

- Small, freeform pool
- Wedding cake stairs
- Two swim outs
- Gradual slope







# compositepoolsUSA.com FREEFORM POOLS

**DELAWARE**  
11' wide x 20' long  
3'5" to 5' deep

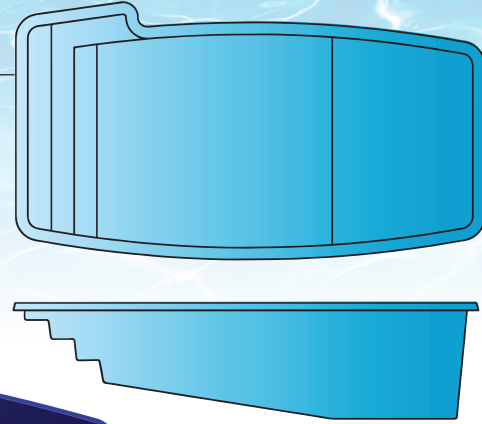

- features:
- Small pool
  - Gradual slope
  - Full width stair entry

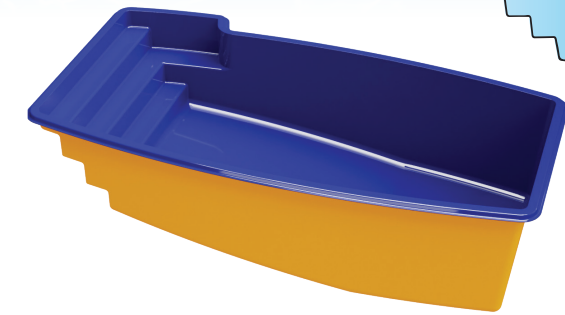

**FLORIDA**  
9' wide x 18' long  
4'3" deep

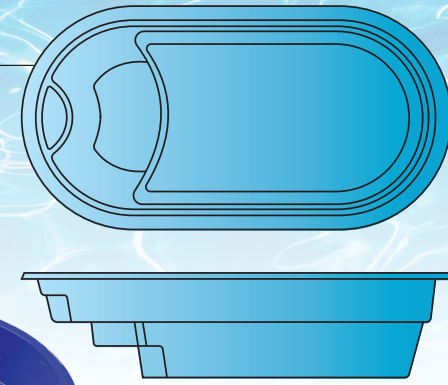

- features:
- Small, oval pool
  - Constant depth/Flat bottom
  - Perimeter convenience ledge
  - Built in steps
  - Built in seating benches

**SEMI-RECTANGULAR NORTH AMERICA**  
12' wide x 27' long  
4'3" deep

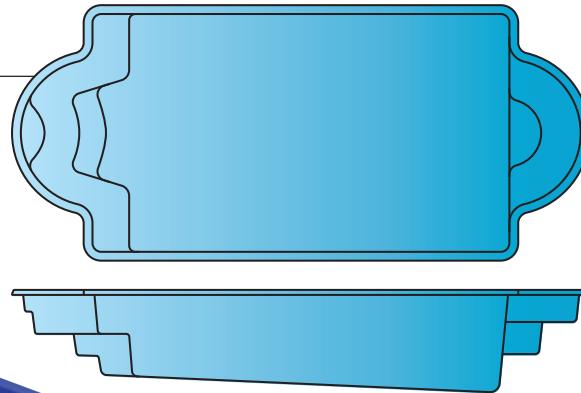

- features:
- Small, semi-rectangular pool
  - Built in steps
  - Built in seating benches



**INDEPENDENCE**  
10' wide x 17' long  
4' deep

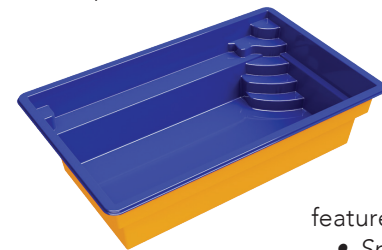
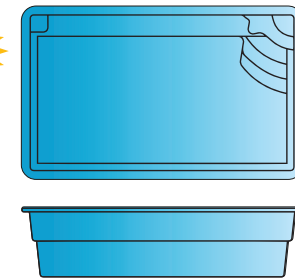

- features:
- Small, rectangular pool
  - Auto cover ready
  - Constant depth/Flat bottom
  - Corner stair entry
  - Unobstructed swim lane

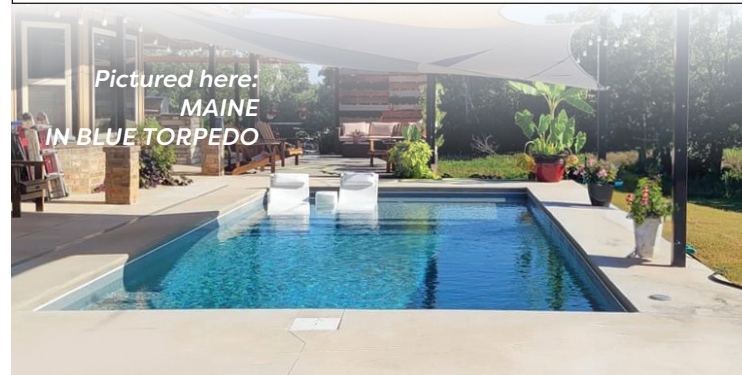

# compositepoolsUSA.com RECTANGULAR POOLS

**GEORGIA**  
16' wide x 44' long  
3'7" to 8'1" deep

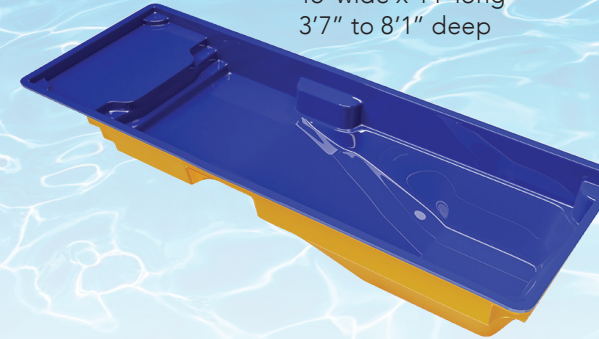
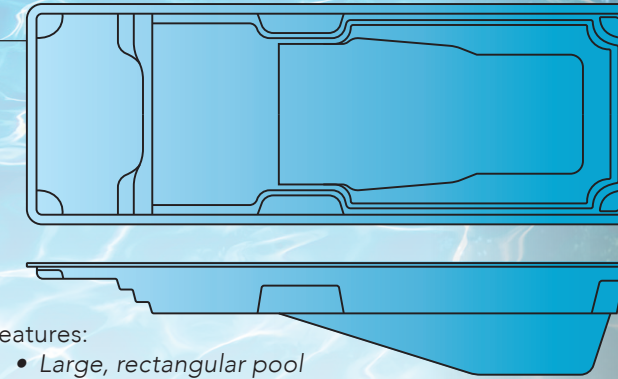

- features:
- Large, rectangular pool
  - Auto cover ready
  - Built-in Tanning Ledge 12" deep
  - Flat shallow end, gentle slope, deep end hopper
  - Multiple entry/exit points
  - Wrap around deep end bench
  - Perimeter convenience ledge

**OHIO**  
16' wide x 40' long  
3'6" to 6'10" deep

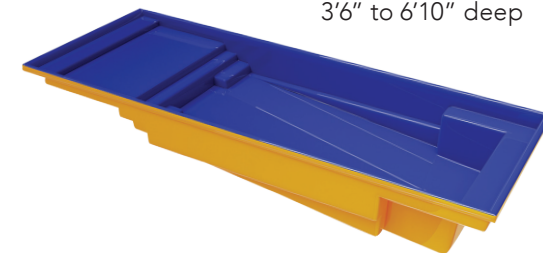
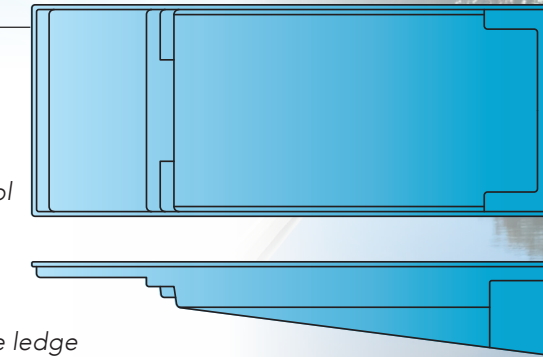

- features:
- Large, rectangular pool
  - Built-in Tanning Ledge 12" deep
  - Gradual slope
  - Auto cover ready
  - Perimeter convenience ledge
  - Wrap around deep end bench



California available in 2 sizes

**NEW!** Large Built-in Spa

**CALIFORNIA 30**  
14' wide x 30' long  
3'6" to 6'8" deep

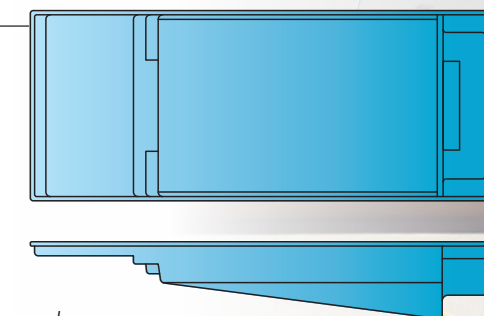

**CALIFORNIA 40**  
16' wide x 40' long  
3'6" to 6'8" deep

- features:
- Large, rectangular pool
  - Large built-in spa
  - Built-in Tanning Ledge 12" deep
  - Gradual slope
  - Auto cover ready
  - Perimeter convenience ledge
  - Wrap around deep end bench & steps



Our Rectangular pools add timeless elegance to your space with the simplicity of clean, straight lines. They include modern features for comfort and functionality. Plus, they maximize limited space so you get the most enjoyment out of your available square footage.



1-855-464-3101 • info@compositepoolsusa.com



1-855-464-3101 • info@compositepoolsusa.com



**TENNESSEE**  
16' wide x 38' long  
3'6" to 5'10" deep

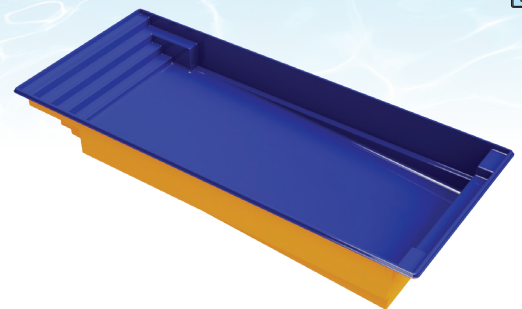

- features:
- Large, rectangular pool
  - Auto cover ready
  - Gradual slope
  - Full width stair entry
  - Full width deep end seating bench
  - Perimeter convenience ledge

**MAINE**  
14' wide x 30' long  
3'6" to 5'10" deep

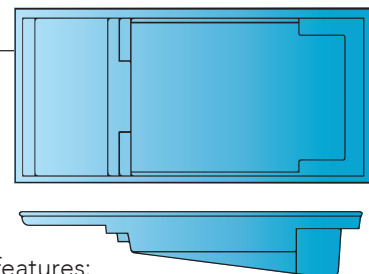
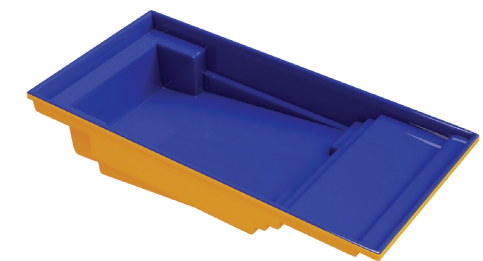

- features:
- Medium, rectangular pool
  - Auto cover ready
  - Gradual slope
  - Built-in Tanning Ledge 12" deep
  - Wrap around deep end seating bench
  - Perimeter convenience ledge

**NEW HAMPSHIRE**  
**AVAILABLE IN TWO WIDTHS**

- 14' wide x 30' long
- 12' wide x 30' long
- 3'6" to 6' deep

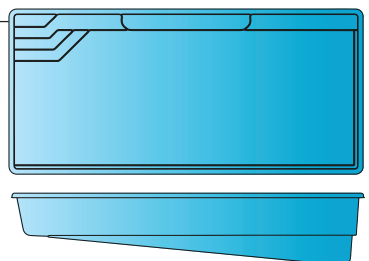

- features:
- Medium, rectangular pool
  - Auto cover ready
  - Gradual slope
  - Unobstructed swim lane
  - Full length seating bench



1-855-464-3101 • info@compositepoolsusa.com

**MASSACHUSETTS**  
12' wide x 26' long  
3'6" to 5'6" deep

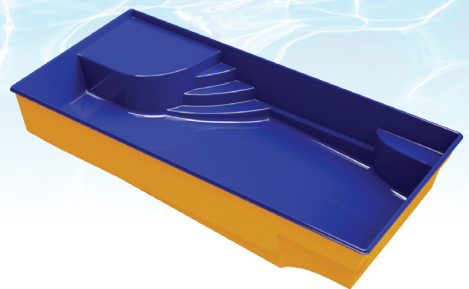

- features:
- Small, rectangular pool
  - Auto cover ready
  - Gradual slope
  - Built-in Tanning Ledge 12" deep
  - Shallow & deep end entry points
  - Perimeter convenience ledge

**INDIANA**  
12' wide x 25' long  
4'6" deep

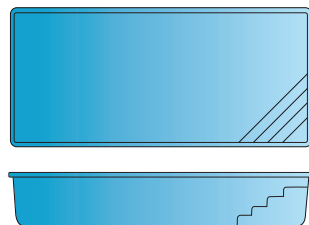
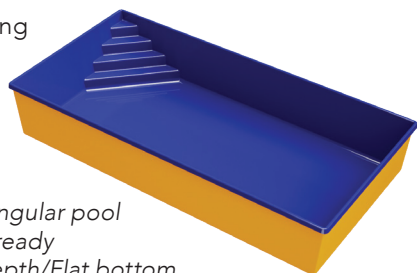

- features:
- Small, rectangular pool
  - Auto cover ready
  - Constant depth/Flat bottom
  - Corner stair entry
  - Unobstructed swim lane

**AVAILABLE WITH BENCH SEATS OR WITHOUT**

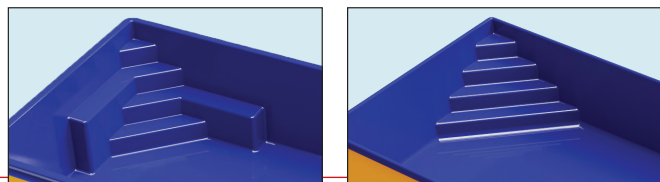

**ILLINOIS**  
12' wide x 24' long  
3'9" to 5'4" deep

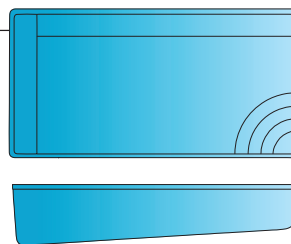
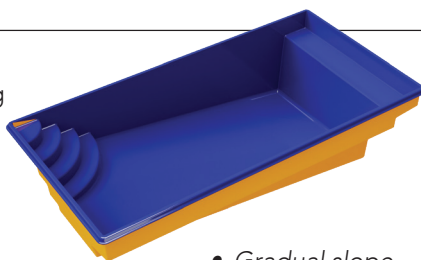

- features:
- Small, rectangular pool
  - Auto cover ready
  - Gradual slope
  - Corner wedding cake stair entry
  - Full length & width seating bench

**Introducing the New Mexico Pool & Spa Combo**

**YOU CHOOSE THE ARRANGEMENT:**  
Spa can be installed at either end; elevated or flush with pool

**NEW MEXICO 10Wx28 SPA COMBO**  
10' wide x 28' long  
4'4" deep



- features:
- Versatile spa position to suit your preference
  - Narrow, rectangular pool
  - Auto cover ready
  - Constant depth/ Flat bottom
  - Tanning Ledge
  - Perimeter convenience ledge
  - Multiple seating benches/exit points

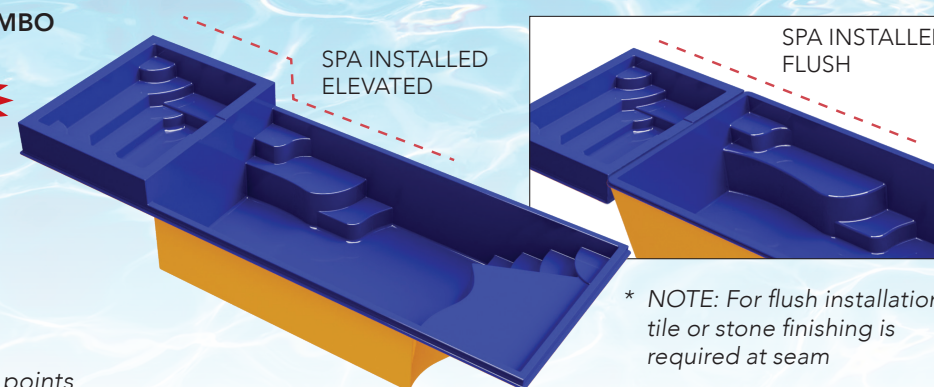

\* NOTE: For flush installation, tile or stone finishing is required at seam

**NEW MEXICO 10Wx20**  
10' wide x 20' long\*  
4'4" deep

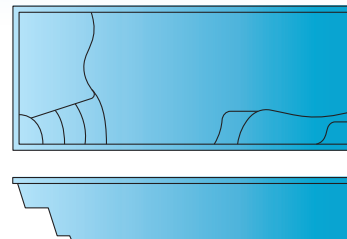

**NEW MEXICO 10Wx24**  
10' wide x 24' long\*  
4'4" deep

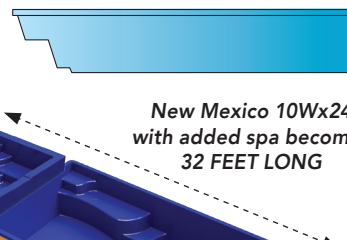

**\* Make it a combo!**

Add the 8'x10' spa to New Mexico 10Wx24 pool to create a Pool Spa Combo 10' wide x 32' long

\* The 8'x10' spa may only be combined with 10 foot wide models

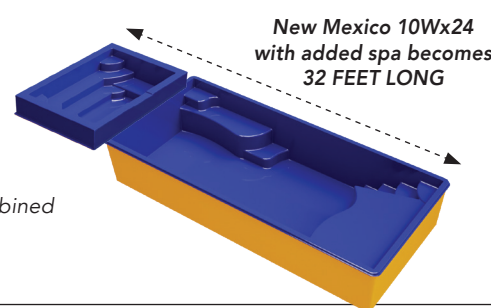

**New Mexico Pools Now Available in Larger Widths**

**NEW MEXICO 12Wx24**  
12' wide x 24' long  
4'4" deep



**NEW MEXICO 14Wx30**  
14' wide x 30' long  
4'4" deep

**NEW MEXICO 16Wx35**  
16' wide x 35' long  
4'4" deep

- features:
- Small, rectangular pool
  - Auto cover ready
  - Constant depth/Flat bottom
  - Tanning Ledge
  - Perimeter convenience ledge
  - Multiple seating benches/exit points



Pictured here: OXFORD BLUE



**ENJOY THE FLEXIBILITY OF MODULAR POOL DESIGN**

A POOL AND SPA COMBO THAT ALLOWS YOU TO CONFIGURE YOUR OWN BACK YARD OASIS

NEW MEXICO W/SPA AT DEEP END

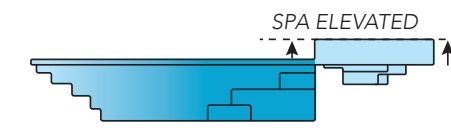
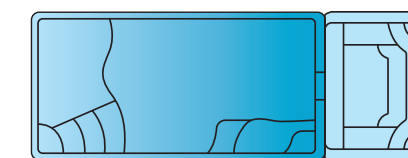

NEW MEXICO W/SPA AT SHALLOW END

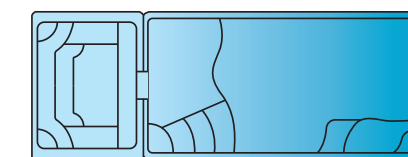

1-855-464-3101 • info@compositepoolsusa.com



**SOUTH CAROLINA**  
**AVAILABLE IN TWO LENGTHS**  
 10' wide x 20' long  
 10' wide x 16' long  
 4' deep

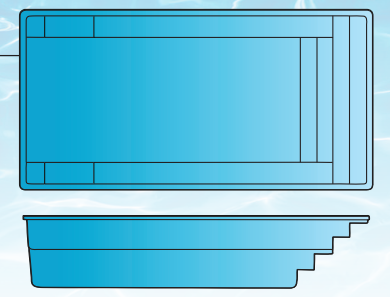

- features:
- Small, rectangular pool
  - Auto cover ready
  - Constant depth/Flat bottom
  - Full length seating benches
  - Full width stair entry



**NEW JERSEY**  
 10'10" wide x 17'3" long  
 4'6" deep

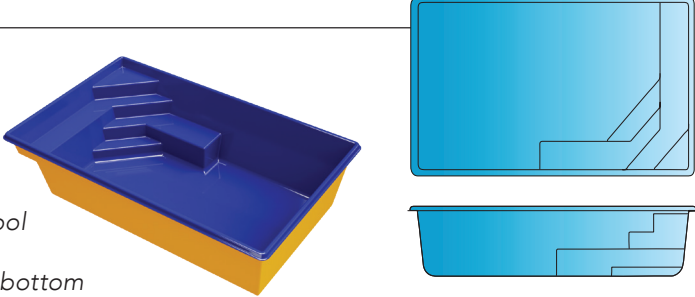

- features:
- Small, rectangular pool
  - Auto cover ready
  - Constant depth/Flat bottom
  - Corner stair entry
  - Built in seating benches

**INDIANA 65 LAP POOL**  
 12' wide x 65' long  
 4'6" deep



- features:
- Auto cover ready
  - Stairs at both ends

**LAP POOL**  
**AVAILABLE IN ANY CUSTOM LENGTH UP TO 65'.**  
 Color selection is limited

1-855-464-3101 • info@compositepoolsusa.com

**Rhode Island available in 3 sizes**

- RHODE ISLAND 20**  
9'6" wide x 20' long  
4' deep
- RHODE ISLAND 8**  
8' wide x 20' long  
4' deep
- RHODE ISLAND**  
9'6" wide x 14'6" long  
4' deep

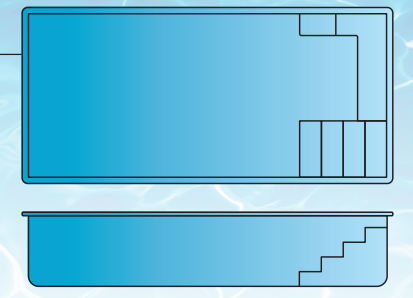

- features:
- Small, rectangular pool
  - Auto cover ready
  - Constant depth/Flat bottom
  - Convenient stair entry
  - Built in seating bench

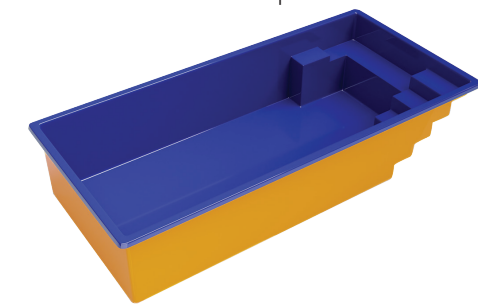

**Indianapolis available in 2 sizes**

- INDIANAPOLIS 22**  
10' wide x 22' long  
4'6" deep
- INDIANAPOLIS 26**  
10' wide x 26' long  
4'6" deep

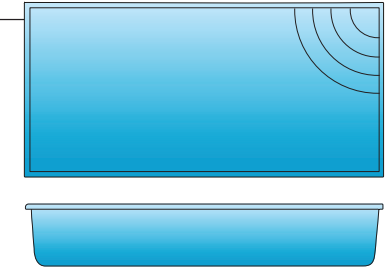

- features:
- Small, rectangular pool
  - Auto cover ready
  - Constant depth/Flat bottom
  - Corner stair entry
  - Unobstructed swim lane

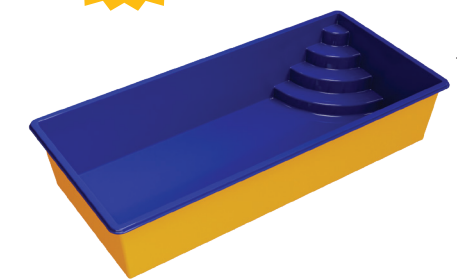

Indianapolis Pool with Puerto Rico Spa



**Make it a combo!**  
 Choose any compatible pool and spa and we'll combine them to make a pool spa combo that suits your preference.

**MONTANA**  
 7'4" wide x 10'4" long  
 2'9" deep



**MONTANA WITH SPILLWAY**  
 8'10" wide x 10'4" long  
 2'9" deep



**VERMONT**  
 10'2" wide x 10'2" long  
 3'4" deep

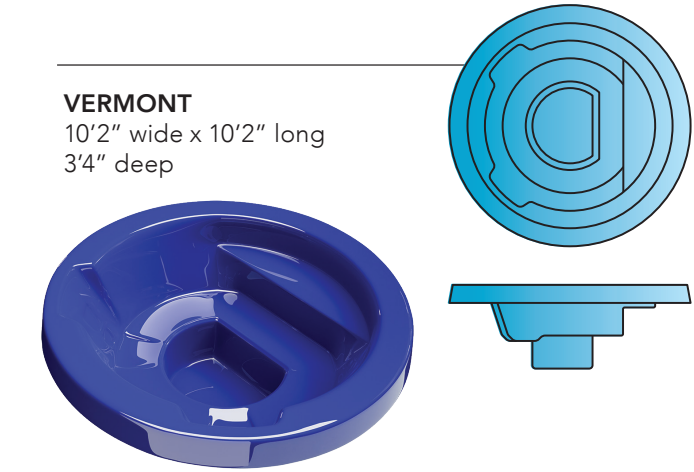

**SOUTH DAKOTA 7'9"**  
 7'9" wide x 7'9" long  
 3' deep

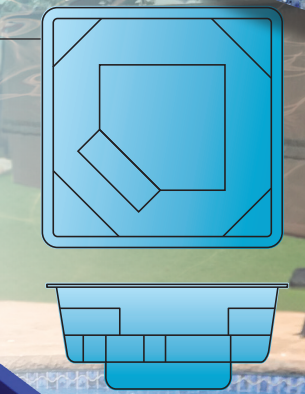

**NEW SIZE AVAILABLE: SOUTH DAKOTA 6'9"**  
 6'9" wide x 6'9" long  
 3' deep

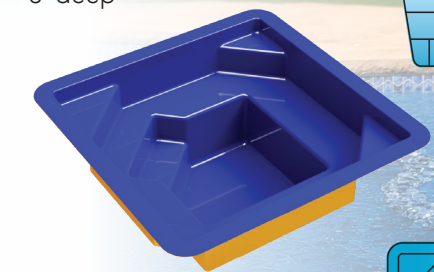

**SOUTH DAKOTA 7'9" WITH SPILLOVER**  
 7'9" wide x 7'9" long  
 3' deep

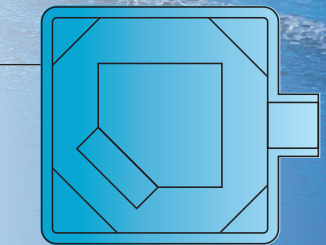

**NEW SIZE AVAILABLE: SOUTH DAKOTA 6'9" WITH SPILLOVER**  
 6'9" wide x 6'9" long  
 3' deep

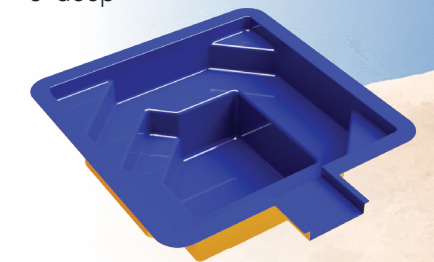

To complement our luxurious line of pools is an equally superb spa. Our spas come in spill over or non-spill over to fit your individual taste. You can listen to the sound of a waterfall while lounging in our soothing spas or sooth yourself in the warm water of the spa after an intense swim.



1-855-464-3101 • info@compositepoolsusa.com



**PUERTO RICO**  
8'2" wide x 10'2" long  
3'4" deep



**PUERTO RICO WITH SPILLOVER**  
8'2" wide x 10'2" long  
3'4" deep

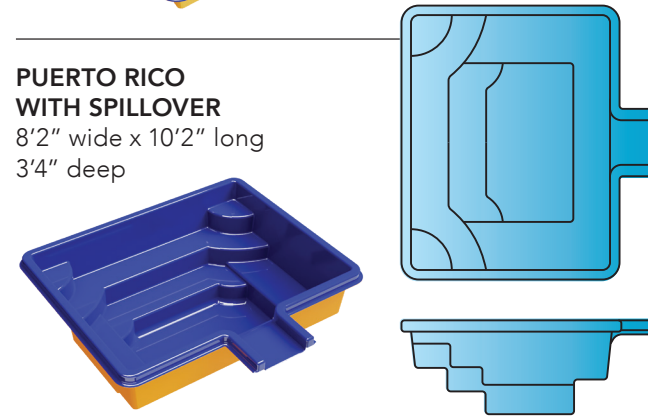

**MICHIGAN**  
8' wide x 8' long  
3'3" deep



**MICHIGAN WITH SPILLOVER**  
8' wide x 8' long  
3'3" deep

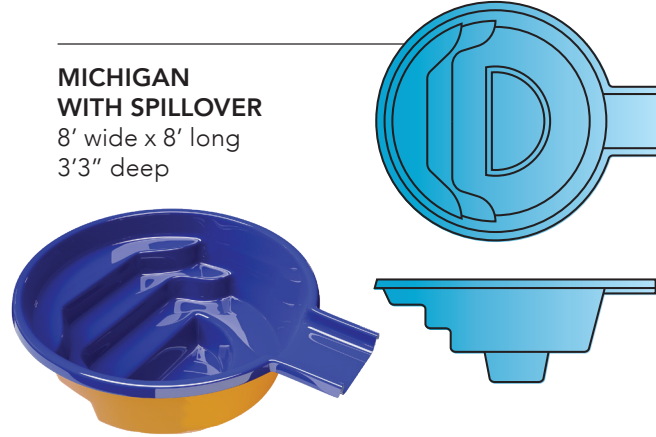

**NORTH DAKOTA**  
7' wide x 7' long  
3' deep



**NORTH DAKOTA WITH SPILLOVER**  
7' wide x 7' long  
3' deep

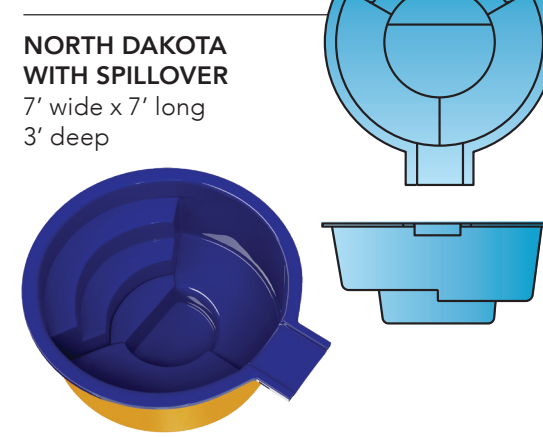

**WASHINGTON**  
7' wide x 15' long  
10" deep



**WASHINGTON WITH WIDE SPILLOVER**  
7' wide x 15' long  
10" deep

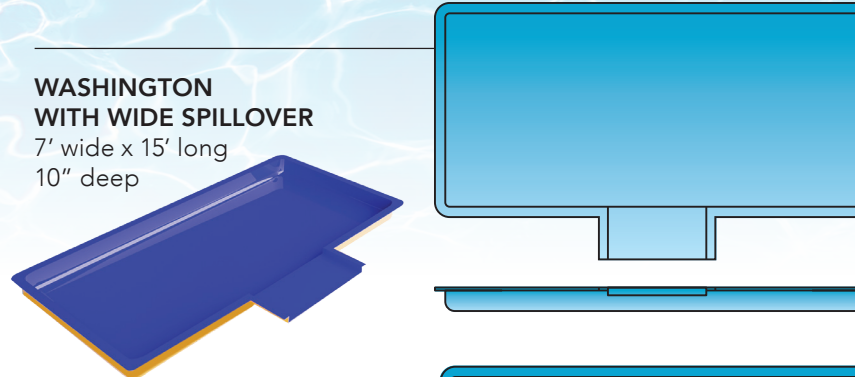

**WASHINGTON WITH SPILLOVER X2**  
7' wide x 15' long  
10" deep

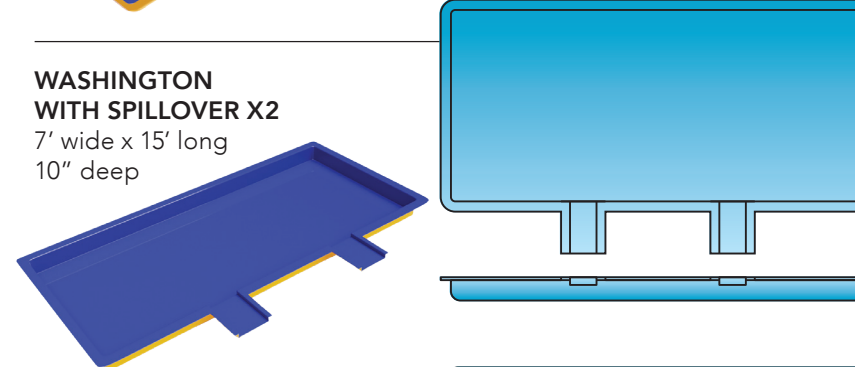

**WASHINGTON WITH SPILLOVER X3**  
7' wide x 15' long  
10" deep

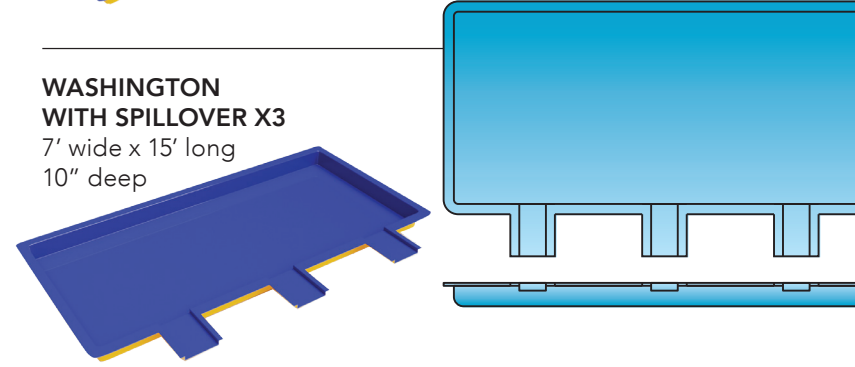

**COLORADO**  
8' wide x 12'4" long  
3' deep

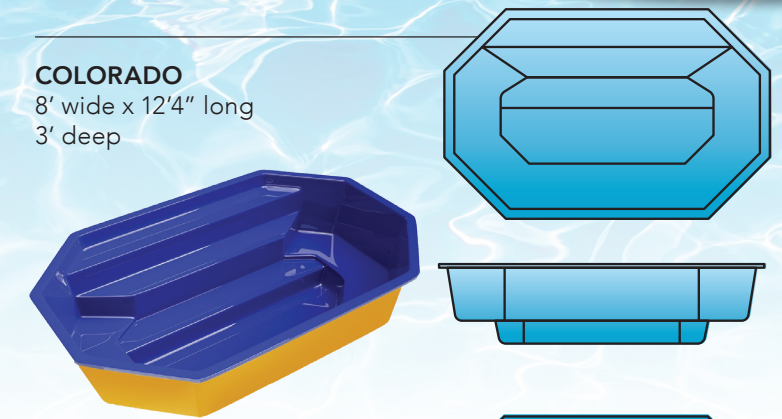

**COLORADO WITH STANDARD SPILLOVER**  
8' wide x 12'4" long  
3' deep

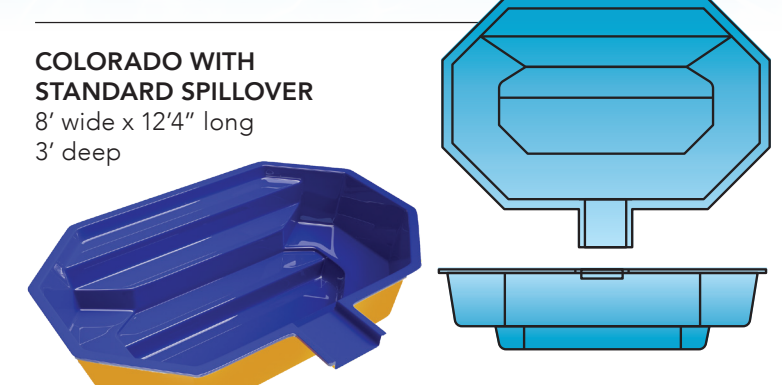

**COLORADO WITH WIDE SPILLOVER**  
8' wide x 12'4" long  
3' deep

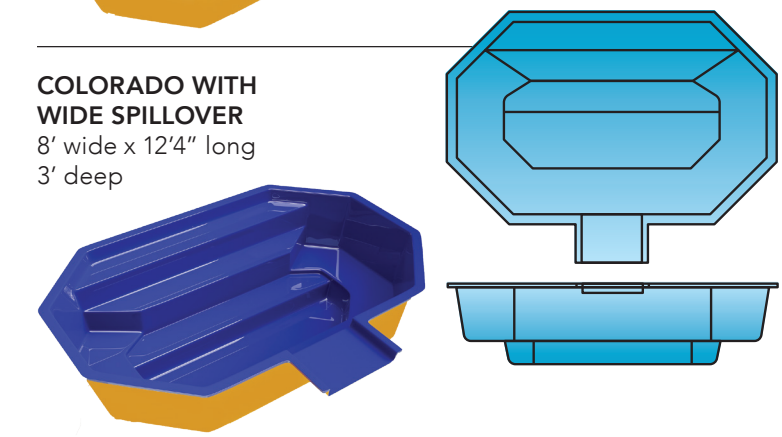

**MAKE IT A COMBO!**

Choose any compatible pool and spa and we'll combine them to make a pool spa combo that suits your preference.

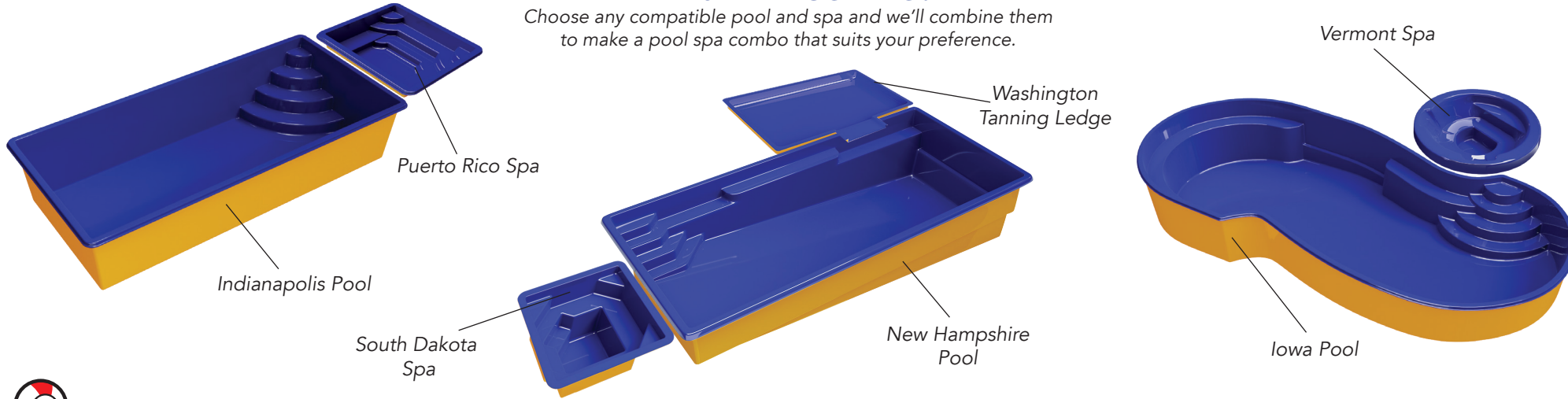



Fiberglass pools from CompositePoolsUSA stand out among other pools. The entire process of installation, from initial layout in your back yard to swimming in your new pool, takes only a few weeks. (Concrete and vinyl liner pools can take up to several months!) With our pools, there is less mess in your backyard with a shorter wait time to enjoy your new pool.



**LAYOUT & EXCAVATION:** The pool layout is carefully marked on the ground for precision. The hole is dug to exacting specifications to achieve the proper shape and depth. Any drainage materials are laid and the ground is leveled and compacted for optimum support.



**DELIVERY & PLACEMENT:** The pool is brought in, set in place and leveled. Then the precision process of filling the pool with water while backfilling for support begins. All plumbing and electrical wiring are completed, pool pump(s) and filtration systems are installed. Each system is checked for operation and quality.



**SETTING & FINISHING:** Depending on the coping and deck materials chosen, poured concrete, pavers, travertine, or bricks are added to complete the installation. The pool and surrounding areas are cleaned and your beautiful new pool is complete!

**Best practices that are essential for safe pool operation:**

- Ensure that the pool is kept in good repair and is not used when there is a missing or broken component.
- Anyone under the influence of alcohol, drugs or stimulants that would impair their abilities or judgment should not use the pool.
- Ensure that the pool is protected by appropriate barriers to unsupervised entry, including fencing with self-latching gates, covers, alarms, etc.

**There are a number of items that are essential for pool safety, all of which should be installed in accordance with the manufacturer's instructions as well as state and local statutes:**

- Safety ropes should remain in place at all times.
- "No Diving" signs should be placed appropriately and in accordance with directions.
- Composite Pools USA provides an area sign which must be permanently and conspicuously affixed in the pool area.
- You must have means of entry into and exit from the pool.
- You must have fencing with a self-latching gate that prevents children and pets from reaching the pool unsupervised, in accordance with local regulations.
- You must have approved drain covers to protect against suction entrapment.
- You must have the minimum required inlets and returns to ensure proper water circulation.
- Appropriate in-pool lighting should be used at night.
- Diving boards and slides require minimum depths and distances and must be installed in strict compliance with the manufacturer's specifications. If your pool is labeled "Non-diving," do not install diving equipment.

**NOTICE:** The specifications in this brochure were believed to be true at the time of printing. However, specifications, standard equipment and options are subject to change without notice. Lengths, widths and depths may vary up to 3%. Measurements are to the widest point on each side of the outside edge. Diving is prohibited on pools less than 8'. Composite Pools USA does not recommend diving or the use of a diving board on any pool model. In some pictures, the safety line rope and floats, and safety signage have been removed from the pool for photographic purposes. The safety line should be permanently attached at all times. We also urge you to use handrails and grab rails in accordance with the PHTA standards.



1-855-464-3101 • info@compositepoolsusa.com

**STANDARD FINISH COLORS**

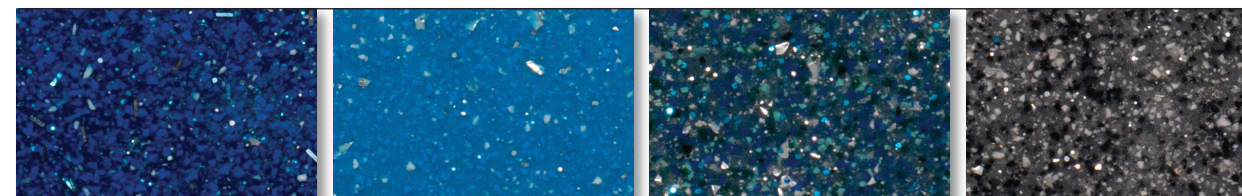

COBALT BLUE      AIR FORCE BLUE      OXFORD BLUE      STEEL GRAY

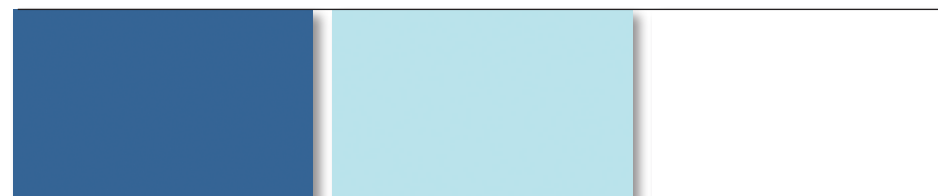

MEDIUM BLUE      SKY BLUE      WHISPER WHITE

**ASK US ABOUT  
 CUSTOM COLORS**

**PREMIUM FINISH COLORS**

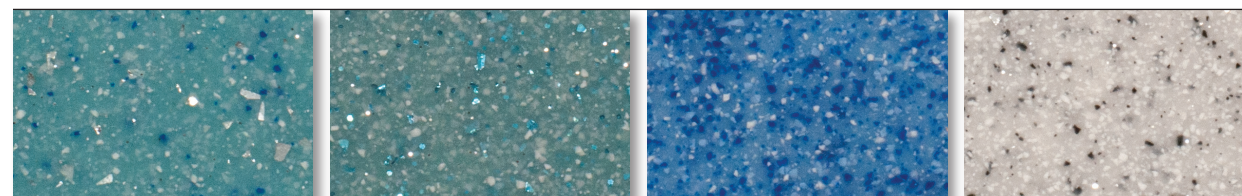

OCEAN BREEZE      CARIBBEAN GREEN      BLUE TORPEDO      ICY WATER

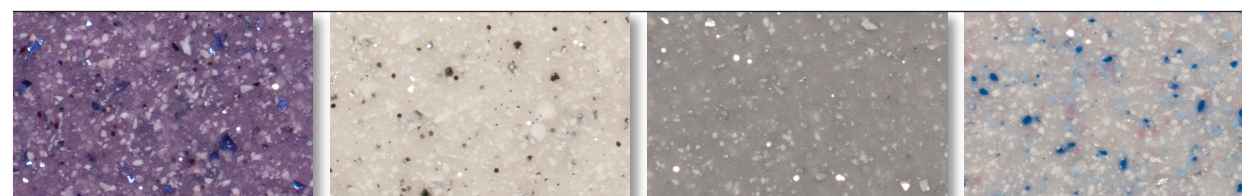

PURPLE PASSION      PEARL GREY      SHARK GREY      RAINBOW SPLASH

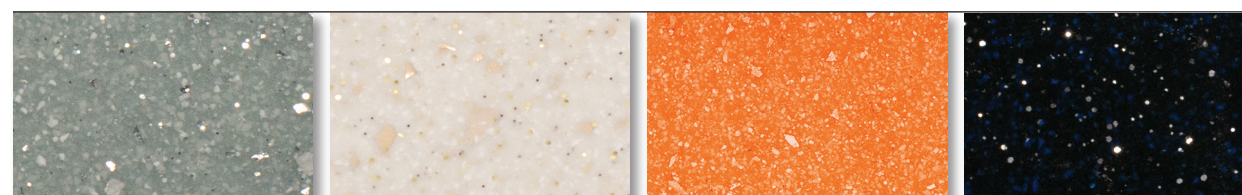

SEAFOAM      MARBLE BEIGE      FRESH SQUEEZED      BLACK GALAXY

**NOTE: DUE TO THE NATURAL REFLECTIVE QUALITY OF MATERIALS, COLORS SHOWN IN PRINT AND ONLINE MAY APPEAR DIFFERENT IN PERSON. To be certain of accurate color appearance, please request a material sample.**

1-855-464-3101 • info@compositepoolsusa.com



*Pictured here:  
 OXFORD BLUE*





compositepoolsUSA.com

TILE OPTIONS

PERIMETER TILES

SUBWAY SERIES

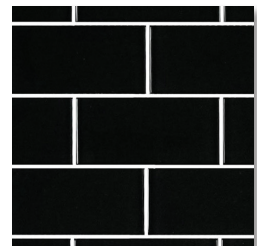

Black 2x4"

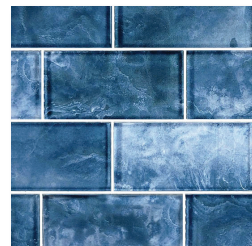

Gunmetal Blue 2x4"



Gray 2x4"

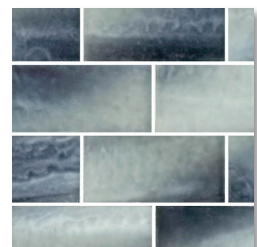

Frosted Night 2x4"

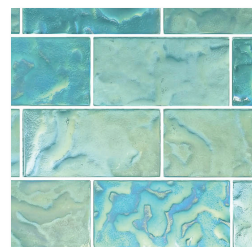

Jade 2x4"

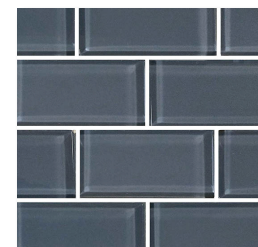

Blue Gray 2x4"

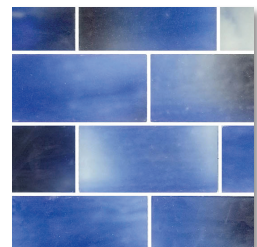

Frosted Sky 2x4"

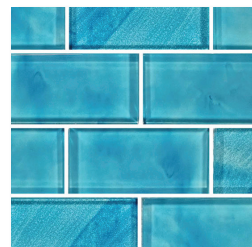

Stratus Aqua 2x4"



Stratus White 2x4"

SEE MORE TILE CHOICES AT:  
[uspooltile.com](http://uspooltile.com)  
[nptpool.com](http://nptpool.com)



1-855-464-3101 • [info@compositepoolsusa.com](mailto:info@compositepoolsusa.com)

ARTISTRY GLASS BLENDS/TWILIGHT SERIES

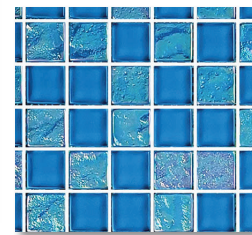

Azure 1x1"

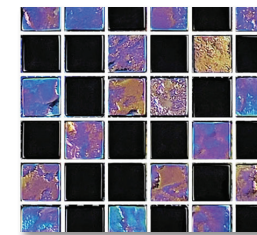

Black 1x1"

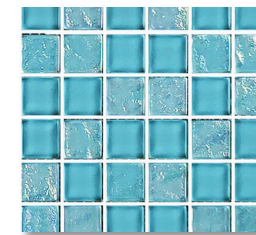

Tuquoise 1x1"

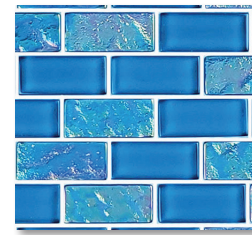

Azure 1x2"

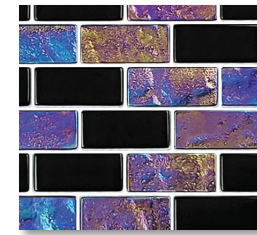

Black 1x2"



Turquoise 1x2"

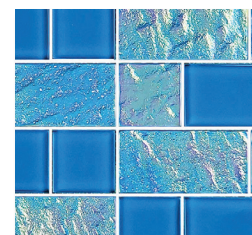

Azure Mixed

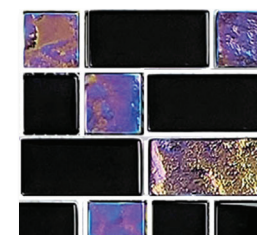

Black Mixed

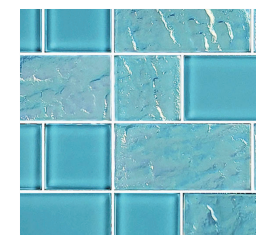

Tuquoise Mixed

ARTISTRY GLASS/WATERCOLOR SERIES

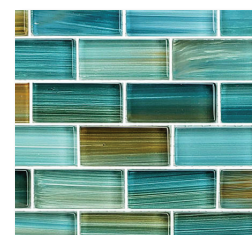

Aqua Blend 1x2"

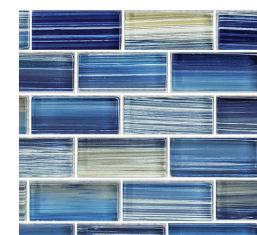

Blue Blend

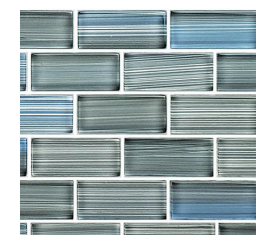

Steel Blue Gray

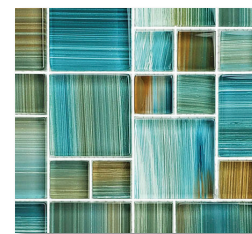

Aqua Blend Mixed

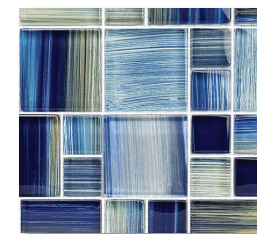

Blue Blend Mixed

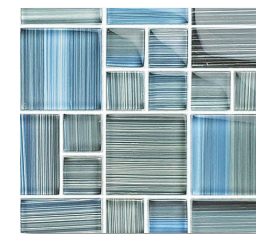

Steel Blue Gray Mixed

TRADITIONAL CERAMIC BORDER TILES

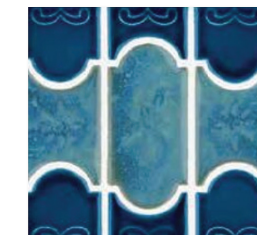

Navy

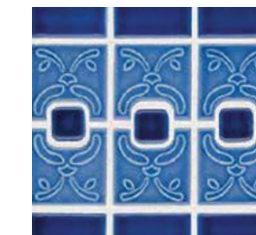

Electric Blue

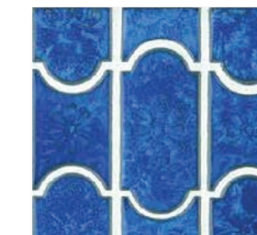

Lake Blue

TITANIUM SERIES GLASS TILES

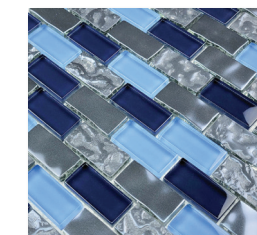

Blue Blend 1x2"

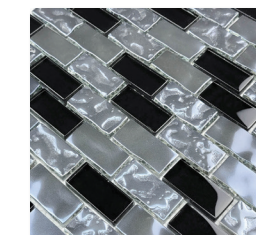

Black Blend 1x2"

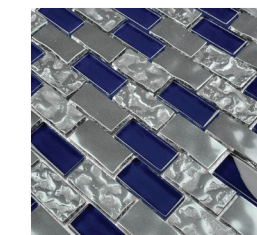

Navy Blend 1x2"

SARGASSO SERIES CERAMIC TILES



Catania Sand 6x6"

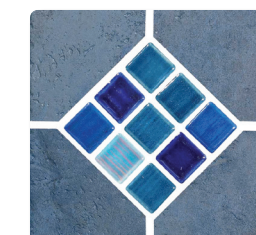

Catania Ocean 6x6"

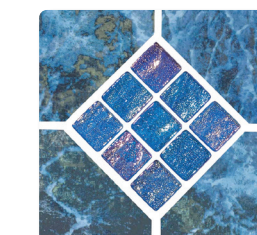

Sargasso 6x6"

**NOTE:** Actual colors of water, finishes, and tile may vary from photos in printed and online material. To be certain of accurate color appearance, please request a material sample.

compositepoolsUSA.com

TILE OPTIONS



BAMBOO SERIES GLASS TILES

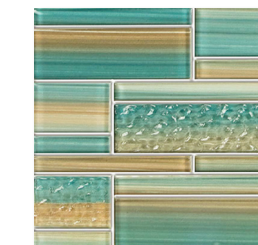

Aqua Marine

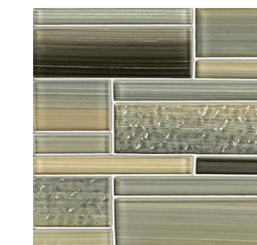

Twilight Gray



Cloud Blue

FUSION MOSAIC PATTERN GLASS TILES



Pinwheel

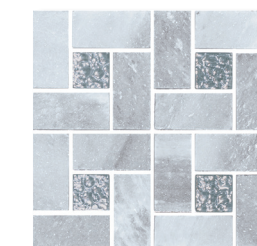

Pinwheel Gray



Imperial

SEE MORE TILE CHOICES AT:  
[uspooltile.com](http://uspooltile.com)  
[nptpool.com](http://nptpool.com)



ASK US ABOUT  
MOSAICS AND CUSTOM  
INLAID DESIGNS

1-855-464-3101 • [info@compositepoolsusa.com](mailto:info@compositepoolsusa.com)







**SLIDES**



**JUMPING ROCKS**

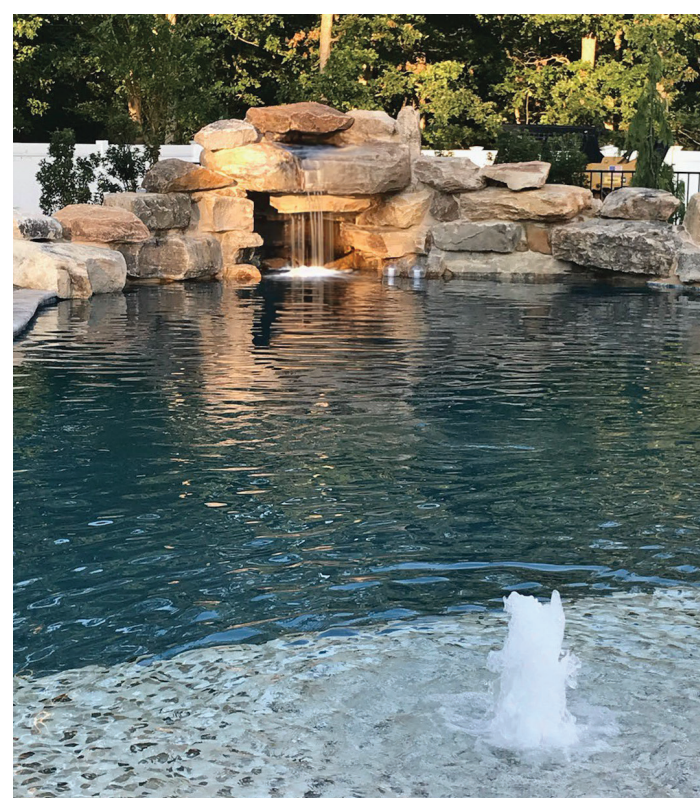

**FOUNTAINS AND WATERFALLS**

*Build the design you want...  
 with the functionality your family needs.*



**HANDRAILS  
 AND  
 LADDERS**



**VACUUMS**



**POOL FROG®  
 MINERAL SYSTEM**

- Kills bacteria 2 ways
- Reduces chlorine use up to 50%
- Precision performance
- Prefilled packs
- 90 day algae protection

*The Frog Mineral delivers sparkling crystal-clear water with little to no maintenance. The lower level of chlorine does not leave bleached clothes or a strong chemical smell. The natural minerals are safe for children and pets. The minerals are soft on your skin and easier on the pool shell.*



**BUBBLERS**



*Adding lights can make a even the most basic pool extraordinary. Entertaining in the evening can become a magical light show.*



**POOL LIGHTING**



1-855-464-3101 • info@compositepoolsusa.com



1-855-464-3101 • info@compositepoolsusa.com





**DECK JETS:**  
 Deck jets form shimmering arcs of water from a deck or patio into a pool or spa. Deck jets can be installed in almost any combination and are adjustable up to 360°. Their dazzling effects can be easily changed to suit any mood or occasion.

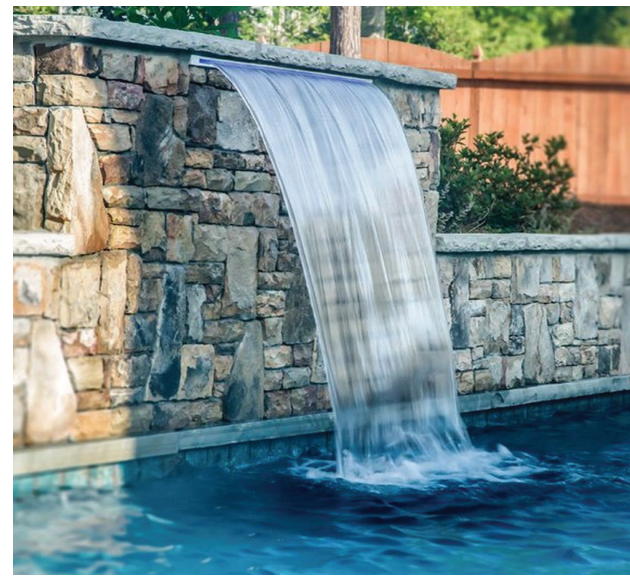

**SHEER DESCENTS:**  
 These unique water features create an impressive visual effect as water flows smoothly and evenly over a sheer vertical surface; the resulting sound is peaceful and relaxing. Visually striking, sheer descents add a sense of tranquility and modern beauty.

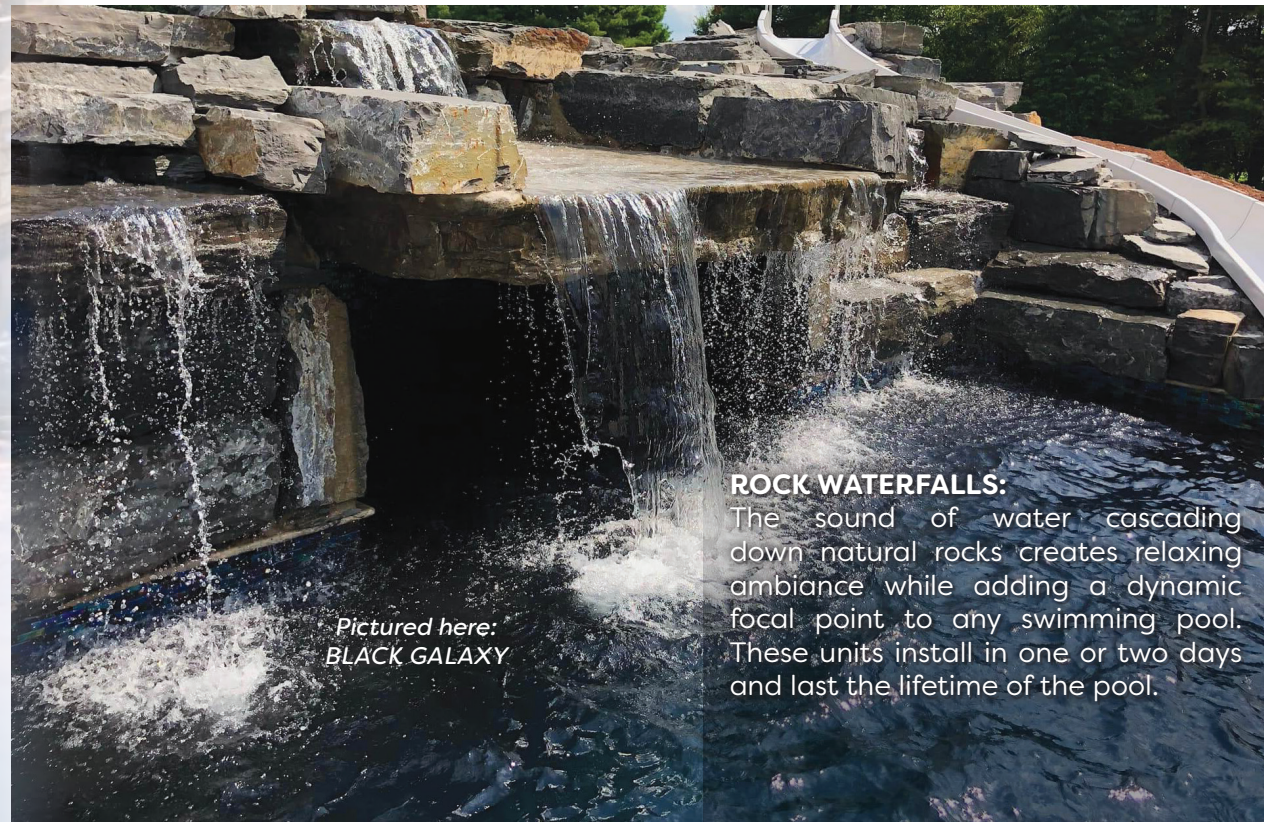

**ROCK WATERFALLS:**  
 The sound of water cascading down natural rocks creates relaxing ambiance while adding a dynamic focal point to any swimming pool. These units install in one or two days and last the lifetime of the pool.

*Pictured here:  
 BLACK GALAXY*

*Fire Bowls, Spa Spill over,  
 Cascades with raised  
 rectangle South Dakota spa*



1-855-464-3101 • info@compositepoolsusa.com



**SWIM SYSTEMS:**  
 Aquatic exercise is one of the most beneficial forms of physical activity for individuals of any fitness level. Gentle and soothing, with little or no stress on joints or bones, swimming has historically been a favored method for staying in shape. Aquatherapy is ideal for individuals who suffer from arthritis, sports injuries, chronic illness, or obesity.



**SAFETY COVERS**  
 Winter pool safety covers provide an essential protective barrier that prevents debris from entering the pool. They're essential in preventing accidental falls into the pool, especially for households with children or pets.

Typically made from durable materials such as mesh or solid vinyl, they can withstand harsh weather conditions year after year. They also help to maintain the cleanliness and chemical balance of the pool water. By minimizing the risk of algae growth, they reduce the need for extensive seasonal cleaning.



**AUTOMATIC COVERS**  
 An automatic swimming pool cover provides one touch convenience eliminating the need for manually covering and uncovering your pool. Their strength and durability can support the weight of a person or pet, preventing accidental falls into the pool.

Covering the pool when not in use helps to retain heat and reduce evaporation, lowering the cost of heating and water replacement.

*Pictured here:  
 South Carolina  
 in Air Force Blue*

1-855-464-3101 • info@compositepoolsusa.com







compositepoolsUSA.com

## DECKING & PATIO



(Grand Ashler Stamped concrete pictured here)



(Stamped Slate pictured here)



### CONCRETE

A poured concrete pool deck provides a smooth yet slip-resistant surface. It can be customized to suit any style preference. Concrete pool decks are low-maintenance and cost-effective. They are durable against extreme weather conditions such as heat, cold, and moisture without cracking or fading. Exposed aggregate is a popular finish achieved by adding colored stones, beads, seashells, or sea glass to the mix.

### NATURAL STONE

A natural stone pool patio is a luxurious and elegant addition to any outdoor space. Made from natural stone such as travertine, bluestone, limestone, or slate, these patios provide timeless beauty and sophistication. The unique textures and colors of natural stone blend seamlessly with the surrounding landscape. Natural stone pool patios are highly durable, slip-resistant and inherently remain cool underfoot on hot summer days.

### MANUFACTURED STONE PAVERS

Made from high-quality materials such as concrete or natural stone, pavers can withstand heavy foot traffic and harsh weather conditions. Their interlocking design provides stability by preventing shifting and uneven settling. Manufactured pavers come in a wide range of styles, allowing endless design possibilities. Additionally, their non-slip surface provides a safe and comfortable walking surface, reducing the risk of accidents around the pool.

compositepoolsUSA.com

## RETAINING WALLS



Pool color pictured here:  
Oxford Blue



Pool color pictured here:  
Cobalt Blue



### RETAINING WALLS

Retaining walls are structures designed to hold back soil or other materials and prevent erosion or collapse. They are commonly used in landscaping and construction projects to create level surfaces, prevent landslides, or create usable space on sloping terrain. They can be designed to blend in with the surrounding landscape or create a focal point in a garden or outdoor space.

### NATURAL STONE RETAINING WALLS

Natural material retaining walls are structures made from organic materials found in nature such as rocks, boulders, logs, or timber. Rocks and boulders are commonly used in retaining walls for their inherent ability to withstand pressure from the soil. They can be stacked or mortared together to create a sturdy, attractive and usable design element.

One of the advantages of natural material retaining walls is their ability to blend in with natural surroundings. They can be used to create terraced gardens, define pathways, or provide seating areas.



1-855-464-3101 • info@compositepoolsusa.com



CALL US NOW: 1-855-464-3101 • Open 7 days 9 am - 5 pm • info@compositepoolsusa.com





# **COMPOSITE POOLS USA**

**WHOLESALE FIBERGLASS POOLS,  
TRANSPORTATION & INSTALLATIONS**

**CORPORATE OFFICE:**  
870 Harding Highway, Newfield, NJ 08344

**FACTORY & MAIN DISTRIBUTION YARD IN NEWFIELD, NJ  
AND DISTRIBUTION YARDS IN THESE LOCATIONS:**

Millsboro, DE  
Friedensburg, PA  
Langhorne, PA  
Marietta, OH

Wintersville, OH  
Mogadore, OH  
Fort Wayne, IN  
Wilmington, NC

Daytona, FL  
Tampa, FL  
Houston, TX  
Boulder, CO

**[compositepoolsUSA.com](http://compositepoolsUSA.com) · 1-855-464-3101**

**[info@compositepoolsusa.com](mailto:info@compositepoolsusa.com)**

